

KISSsoft

A Gleason Company

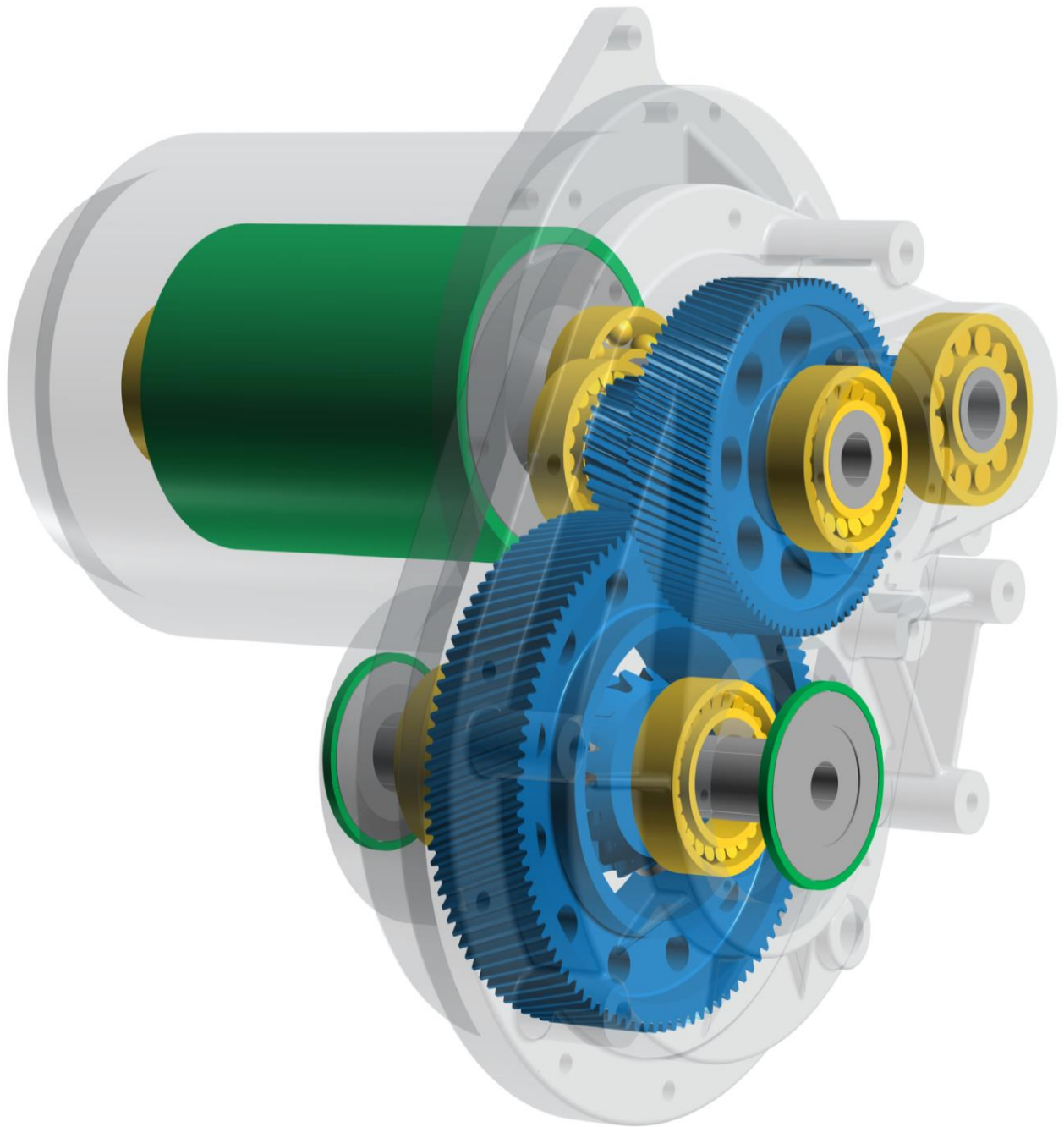

KISSsoft® Software Modules

General

- KISSsoft module as individual modules
- System Module to model complex systems
- Interfaces to other Gleason software, CAD systems and bearing OEM tools

KISSsoft

- Cylindrical, rack & pinion, bevel / hypoid, beveloid, worm, face gears, crossed axis helical, non-circular gears
- Involute and non-involute gears, symmetrical and asymmetrical involute teeth
- Shafts and rolling element bearings, hydrodynamic bearings, coaxial shaft systems, bearing stress and load distribution
- Shaft modal analysis and unbalance response
- Shaft-hub connections, bolted connections
- Spring analysis, chains and belts, clutches
- Tolerance stack-up, local stress analysis, Hertzian contact stress, spindles
- Plastic gear materials manager
- Load spectrum from time series

System Module

- Includes scripting language
- Machine element library to build own models
- Programming language module
- Housing stiffness import from FEM (ABAQUS, ANSYS, NASTRAN, ...)
- System efficiency calculation, thermal rating
- Load spectrum rating on system level
- Modal analysis / natural frequencies calculation on system level
- Forced response analysis (gear mesh excitation, torque ripple, ...)

CAD interfaces and supported formats

- Interfaces to Gleason software like GEMS®, GAMA®
- 2D CAD export in neutral / graphic formats
- Gear geometry 3D export to CAD systems
- Interfaces to multi body systems software

Databases

General

- User editable database
- Bearings: FAG / INA, SKF, Koyo, Timken, ...
- For standard bearing data and bearing inner geometry

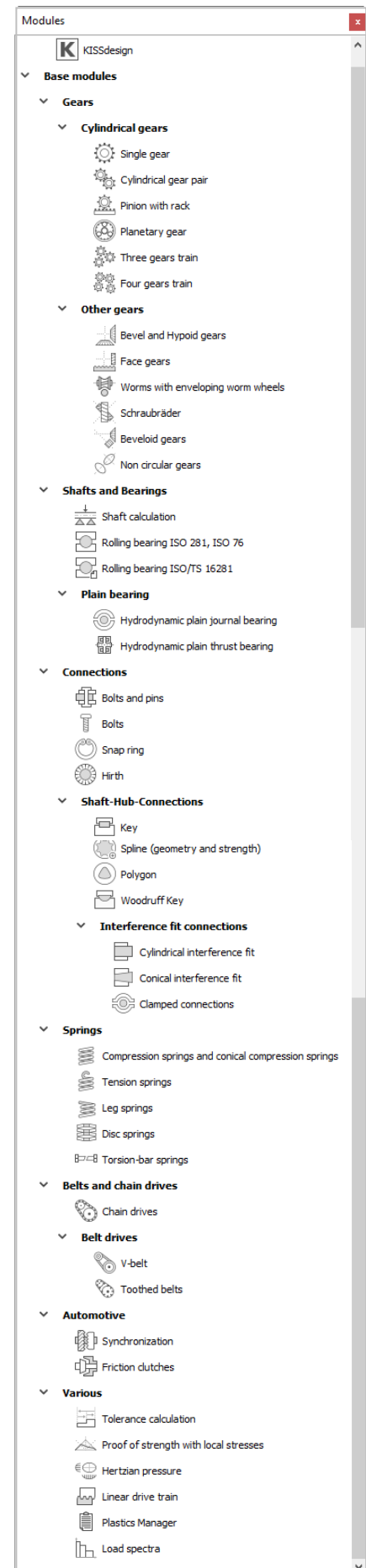

Systems Module

Overview

The System Module combines kinematic analysis, lifetime calculation, 3D graphics, system reports with a programming language. It is the tool of choice for strength and lifetime analysis of various kinds of drive trains and gearboxes. The System Module lets the user do quick and detailed parametric studies of a complete power train in very little time to compare different variants of a concept or to analyze a given design for different loads.

In the System Module, all parts (gears, shafts, bearings, connections) of the gearbox are linked and the strength / lifetime analysis is performed simultaneously for all elements. A three-dimensional graphical presentation of the current state of the system immediately shows the geometrical influence of every change in parameters. This approach greatly accelerates the design process and results in a much more balanced design even during the concept phase.

The machine elements calculated range from gears, shafts, bearings to shaft-hub connections. This will result in a more balanced starting design and fewer modifications will be necessary further down in the design process to reach an optimized design. Furthermore, documentation of the calculation is simplified and all calculation data for a whole drive train or gearbox is stored in a single file. The System Module uses KISSsoft for the strength and lifetime calculations of the various machine elements.

Kinematics Calculation:

- Speed, torque, and power for complex systems including gears, couplings, speed and torque limiter, multiple boundary conditions
- Modelling of planetary systems like Ravigneaux, Wolfrom, Wilson, Simpson
- Differentials, (with bevel or spur gears), chain and belt transmissions
- Couplings can be activated and deactivated, slippage considered
- Allows for modelling of CVT transmissions
- System ratio and mesh ratio table in Kinematics tab
- Switching matrix for defining gear speeds

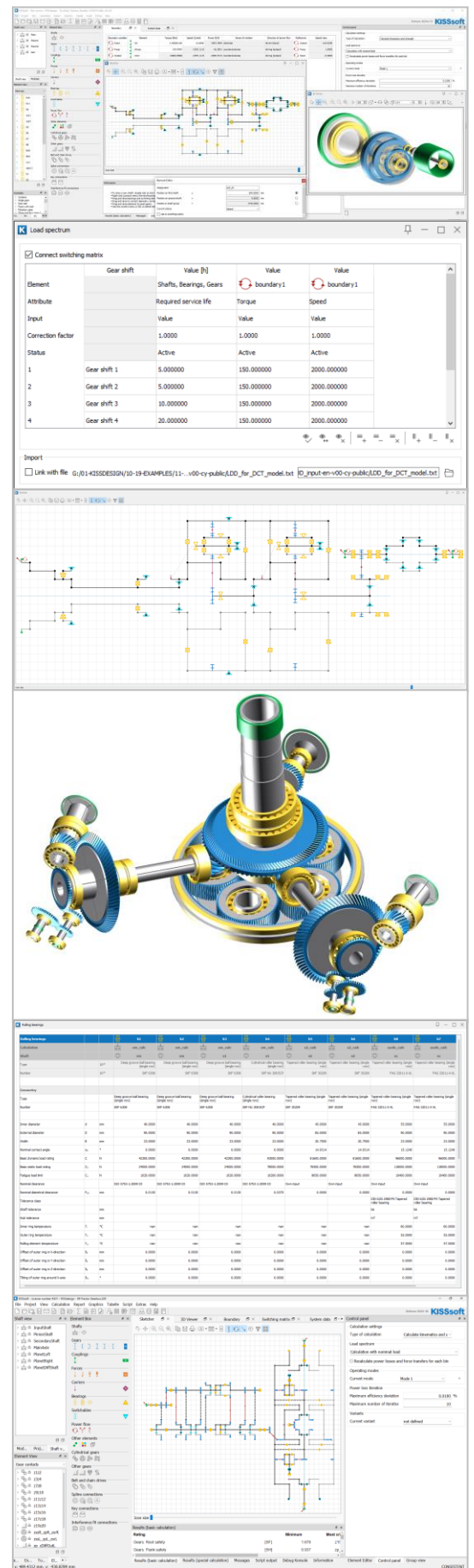

System Module, analysis

Calculations in the System Module

Integrated strength and lifetime calculation:

- With integrated KISSsoft calculation modules
- System deflection is considered in tooth contact analysis
- Calculations with load spectra for all machine elements in the model
- Integrated programming language for implementation of special functions
- Animation of gear movement
- Cut view and deformed systems display
- Wizards, libraries, and toolboxes for quick modelling

Machine element library

- Spur / helical gear pair and chain of gears
- Planetary gears, compound planetary gears
- Bevel and hypoid gears
- Worm gears, crossed axis helical gears
- Face gears with and without offset
- Shaft-bearing systems, coaxial shafts
- Shaft-hub connections
- Synchronizer

3D representation

- Automatic 3D-display (based on the data defined in KISSsoft)
- 3D-model export to CAD platforms, gearbox housing import, *.step file
- Collision check with imported CAD geometry

Typical applications

- Analyze wind turbine gearboxes for different loading conditions
- Check that of a plastic gear set for an automotive actuator fits into the design space
- Calculate power flow in CVT transmission
- Maintain a database of geared motor gears
- Compare different transmission layouts with respect to efficiency
- Estimate the manufacturing cost of a gearbox even during the design phase
- Optimize bearing lifetime by variation of the gear's positions on a shaft
- Create specific reports e.g., for certification
- And many more ...

Boundary condition	Element	Torque [Nm]	Speed [1/min]	Power [kW]	Sense of rotation	Direction of power	Reference	Speed ratio
gear1	gear1	412.0297	-1.0376.1146	40.0000	counter-clockwise	driving (output)	m1	-1.2463
gear2	gear2	51.8957	1.0376.1146	44.7242	clockwise	driving (output)	m1	0.0123
m1	dm1	604.2300	30069.0000	1323.2102	clockwise	driving (output)	aut1	0.0123
m2	dm2	604.2300	30069.0000	1323.2102	clockwise	driving (output)	aut1	0.0123
dm1	dm1	2.9221	-5266.0269	-1.0000	counter-clockwise	driving (output)	m1	-6.3980
dm2	dm2	2.9221	-5266.0269	-1.0000	counter-clockwise	driving (output)	m1	-6.3980
aut1	aut1	-78011.0000	258.0023	-2187.6562	clockwise	driving (output)	m1	81.0419
pump1	pump1	-25.9078	7371.7628	-35.0000	clockwise	driving (output)	m1	2.8264
pump2	pump2	-25.9078	7371.7628	-35.0000	clockwise	driving (output)	m1	2.8264
output_gt	Intermedia	-662.7606	4117.3660	-372.0000	clockwise	driving (output)	m1	5.0284

Housing stiffness matrix import

The housing stiffness and the housing deformation may be considered for the loaded tooth contact analysis in the System Module by means of

- Import of housing stiffness matrix / reduced stiffness matrix from supported FEM codes
- ABAQUS
- ANSYS
- NASTRAN

Features

- Node mapping: connect master nodes of stiffness matrix to the system model bearings
- Deformation vector is calculated inside the System Module using bearing forces and stiffness matrix
- Automatic alignment of stiffness matrix coordinate system to model coordinate system

Modal analysis

- System natural modes and natural frequencies
- Considers bearing operating stiffness matrix
- Considers gear mesh stiffness
- Considers shaft stiffness, inertias and masses
- Animation of modes on system level
- Comprehensive report

Thermal rating

- Calculates power losses due to gear meshes, bearing friction, churning and seal friction torque
- Based on ISO/TS 14179-1 / ISO/TS 14179-2
- For oil bath or forced lubricated systems
- Calculates and lists individual power losses and system efficiency
- Sizing of cooler, calculation of thermal equilibrium, calculation of required oil flow

Gleason GEMS® interface

- Export EPGΣ data from KISSsoft
- Interface to GEMS® and GAMA® through KISSsoft modules

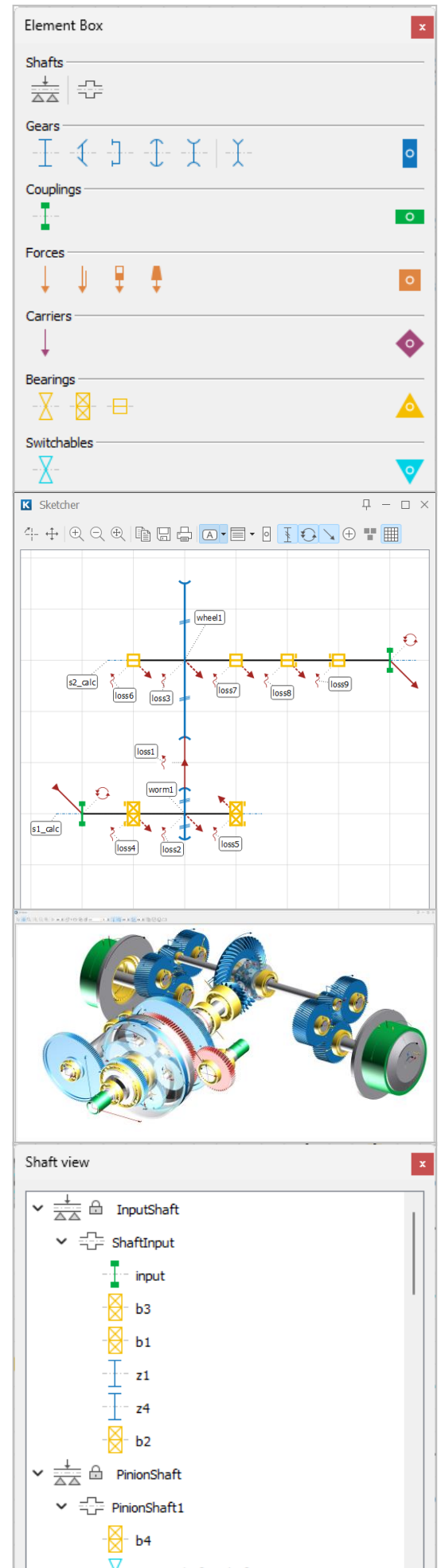

System Module, user input and output Sketcher

The sketcher allows for definition of the topology of a gearbox or transmission as if using pen and paper. Using mouse and keyboard, the system is drawn on a grid. Shafts are the basis of the sketch; elements are put on the shaft by mouse click and elements are connected by a drag and drop approach to define e.g., gear meshes. Layers in the sketch show different information, e.g., the element name. Other features include:

- Manage elements in groups, copy paste
- Arrange elements inside the sketcher to represent the spatial arrangement
- Different graphic options for the representation of elements, power flow, sense of rotation
- ...

Reports

Reports are generated for the whole system or for each calculation. On system level, reports include

- Summary report showing the most relevant results and input data
- List of all bearings, gears, and bearings, to be used as a part list
- Bearing displacements and tilting values, forces, and moments
- Thermal rating report
- ...

Modeling assistance

Assistants for creating models include

- Initial sizing of gears
- Group modeling containing 16+ standard configurations including
- Parallel shaft arrangements, chains of gears
- Planetary arrangements with double planet, Ravigneaux, ...
- Shiftable gears
- ...

Graphics

- 3D System visualization with coordinate grid
- Deformed vs. undeformed system
- Element color and translucency user controlled, cut view, video recording
- Gear teeth 3D geometry representation for cylindrical, bevel and worm gear
- ...

The screenshot displays the KISSsoft software interface, which is used for designing and analyzing gear systems. The top part of the interface shows a table of gear parameters for various configurations. Below this, there are several toolbars and panels for defining gear types and arrangements. A 3D model of a gear assembly is shown in the center, with a coordinate grid overlaid. The bottom part of the interface displays a detailed report or data table for the selected gear configuration.

Name	Number of teeth [z] (-)	Normal module [mm] (mm)	Normal pressure angle [α] (°)	Helix angle [β] (°)	Hand of gear	Profile shift coefficient [x]	Tip diameter r (da) [mm]	Inside diameter r (di) [mm]	Face width [b] (mm)	Mass [m] (kg)	Number [-]
z1	16	0.760	27.000	13.800	helix: left hand	0.0000	14.067	9.000	12.000	0.005	1
z10	25	0.986	27.000	0.000	spur gear	0.0000	25.794	19.000	11.000	0.013	1
z11	16	0.986	27.000	0.000	spur gear	0.0000	18.257	9.000	12.000	0.013	1
z11-2	16	0.986	27.000	0.000	spur gear	0.0000	18.257	9.000	12.000	0.013	1
z12	-55	0.986	27.000	0.000	spur gear	0.0000	-55.153	62.700	11.000	0.044	1
z13	47	1.410	26.000	0.000	spur gear	0.0000	69.019	59.000	12.000	0.064	1
z14	34	1.410	26.000	0.000	spur gear	0.0000	50.690	32.000	15.000	0.110	1
z15	48	1.410	26.000	0.000	spur gear	0.0000	70.429	10.000	12.000	0.323	1
z16	81	0.876	26.000	0.000	spur gear	0.0000	73.030	38.000	14.000	0.307	1
z17	51	1.094	24.200	0.000	spur gear	0.0000	58.507	38.000	9.000	0.091	1
z18	37	1.199	25.000	0.000	spur gear	0.0000	47.458	18.200	9.000	0.091	1
z2	31	0.760	27.000	13.800	helix: right hand	0.0000	25.522	19.000	10.000	0.002	3
z7	-80	0.760	27.000	13.800	helix: right hand	0.0000	-59.433	65.040	12.000	0.014	1

System Module, modal analysis

The eigenfrequencies and eigenmodes of a complete shaft system, including the effect of gear connections between shafts are calculated.

Meshing Stiffness

- ISO 6336 Method B
- Contact analysis per gear pair: with this option, the contact analysis of all active gears is carried out to calculate the mean value of the tangent stiffness at mating gears.
- Infinite: the tooth contact stiffness is assumed to be infinite. Select this option if you want to check limiting conditions.
- Ignored: the tooth contact stiffness is assumed to be zero and therefore, no connection between the vibrating shafts is considered.

Modelling approach

- Only torsional vibrations
- Torsional and bending vibrations
- Gyroscopic effect can be activated or deactivated.

Graphics

- Normalized displacements and rotations
- 3D deformation

Campbell diagram

A Campbell diagram can be used to investigate the effect of shaft speed on the eigenfrequencies. This calculation can be used to define the critical eigenfrequencies for each speed.

Meshing Stiffness

- Includes the same four options as in the modal analysis.

Speed range and number of speeds

- The minimum and maximum values of the speed range of the reference boundary can be given. The Campbell diagram calculation iteratively is carried out at all speeds in the given speed range and produce the required outputs.
- Number of resonance curves can be assigned to see the intersection of orders and eigenfrequencies.

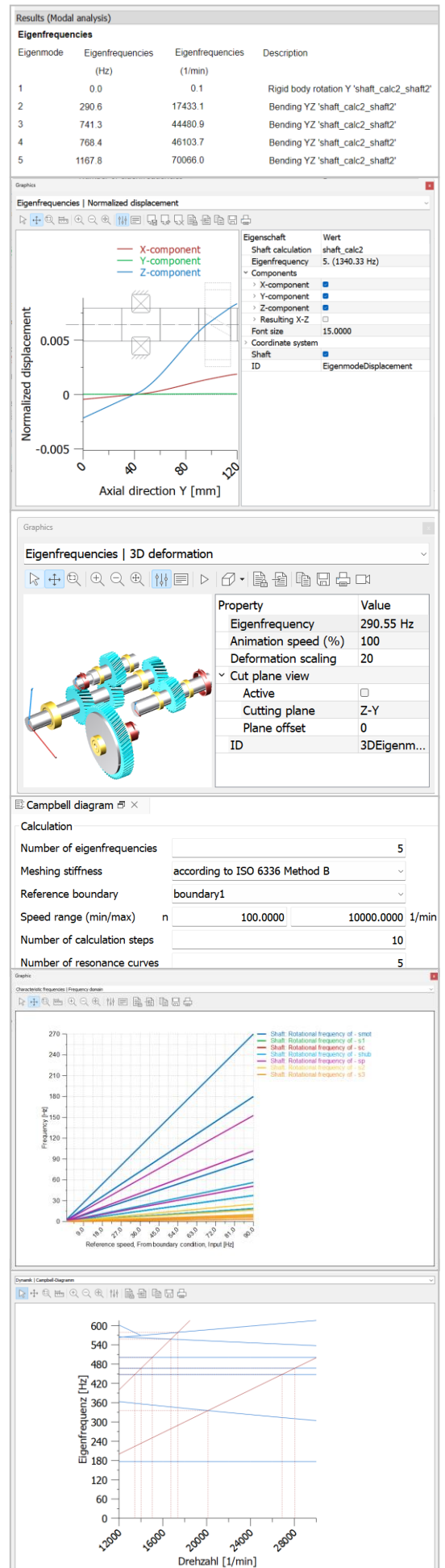

System Module, forced response

Introduction

The powerful and user-friendly forced response analysis in KISSsoft provides the analysts and engineers to perform the dynamic analysis of powertrain systems quickly and efficiently. The vibration characterization of the system under periodic excitations is performed to assess the NVH behavior of a system.

Excitation sources

Three sources of excitation can be modeled:

- Unbalanced masses
- Gear meshing forces: as the main source of excitation, the effects of variable meshing stiffness and transmission error at mating gears are considered.
- Torque ripples: they are periodic excitations in torque, which can result in vibration and noise.
- This effect can usually be observed in many electric motor and combustion engine designs, referring to a periodic fluctuation in the output torque as the motor shaft rotates.

Calculation

The main settings for the calculation process include:

- Minimum and maximum values of the speed range of the reference boundary for the analysis can be given. Forced response iteratively solves the system at all speeds in the given speed range and produce the required outputs.
- Number of harmonics: The number of frequencies of the excitation forces from different sources can be considered.
- Meshing stiffness and transmission error are used to calculate the excitation forces. Forced response offers different types of stiffness calculation based on contact analysis per gear pair as well as the system contact analysis.
- Excitation force type: three different approaches including “tangential stiffness”, “secant stiffness”, and “excitations forces in contact module”.
- Two modelling strategies are available; either to consider only torsional DOF, or bending and torsional DOFs of the flexible shafts to calculate system dynamic response.

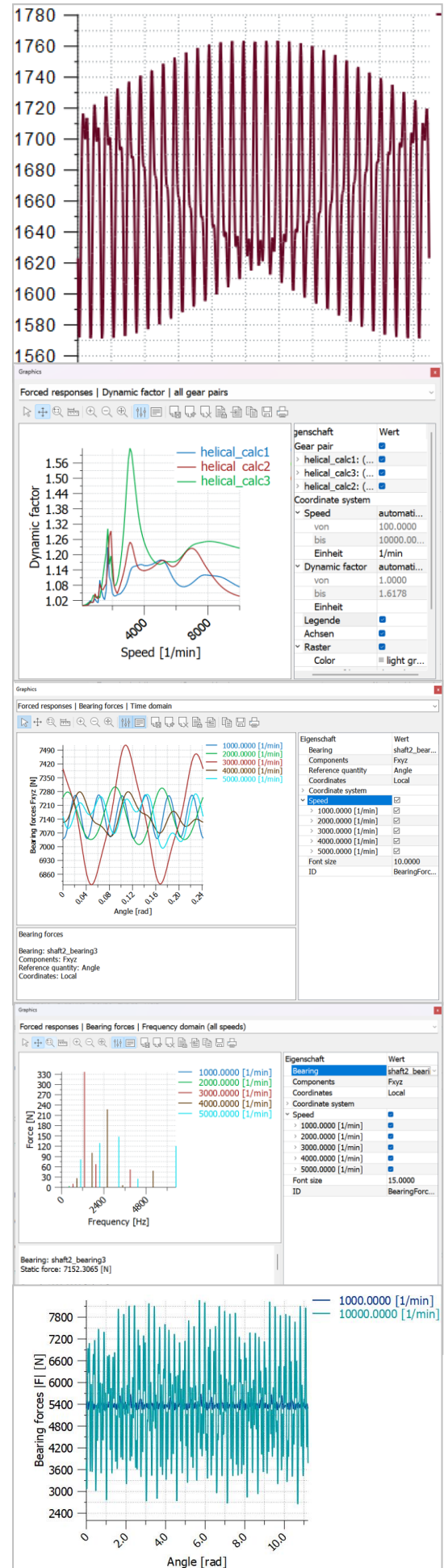

Material damping

In powertrain systems, all deformable elements can dissipate energy when subjected to dynamic deformations. In the forced response analysis of a model in KISSsoft, three different damping sources can be given:

- Damping of bearings and supports
- Structural damping of shafts
- Gear mesh damping

Output data specification

- The results of the forced response analysis can be generated in both the frequency and time domains.
- The quality of the results in time domain can be adjusted by setting the resolution to low, medium, high, or very high.
- In time domain analysis, the end time and step time for generating the output data is adjusted in a way to capture all possible excitations and to complete full periods of the vibrations for all excitation frequencies.
- The output data can be saved in a user-defined folders for further process in other software packages.
- The response and movement of the system's elements as the result of the excitations can be visualized in a 3D view to provide more insights to the response of the system's elements.

Result window

For all active gear pairs, some important results such as gear meshing frequency, maximum dynamic force and dynamic factor at all running speeds are presented.

Graphics

The results and outputs of the forced response analysis can be accessed in the graphics menu including:

- Dynamic factor
- Bearing force and moments
- Shaft outputs
- Gear mesh outputs
- Campbell diagram
- Whirl orbit parameters

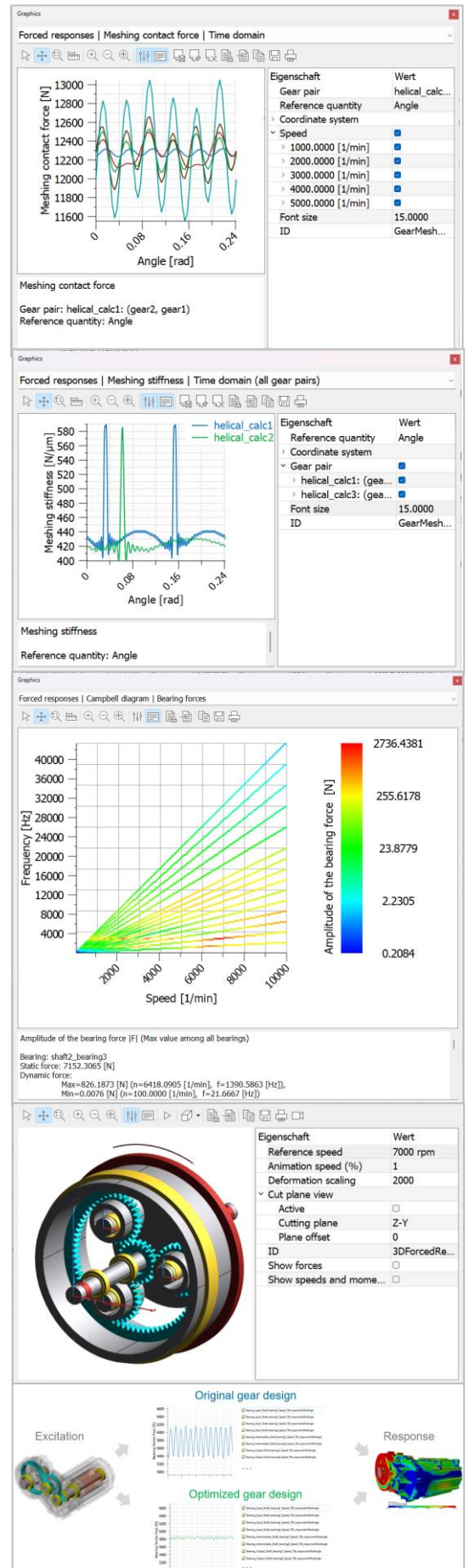

Housing vibration and noise

Overview

For characterization of the NVH properties, a calculation process using KISSsoft and RecurDyn software is offered. By exporting the transient bearing forces from KISSsoft to RecurDyn and applying them to a housing, the housing response may be computed. The approach is fully automated through an interface window in RecurDyn.

Linking System Module and RecurDyn

RecurDyn, by FunctionBay, is a Multibody Dynamics based software with an integrated nonlinear Finite Element Method and a noise tool kit extension. RecurDyn/Acoustics is a noise analysis toolkit that performs the predictive analysis for noise of the mechanical system by confirming which parts of the surface of a flexible body emit more noise and which frequency band ERP is dominant.

Modelling in RecurDyn

FEM modelling in pre-processor, housing or housing with internals

- Mesh generation, define bearing points
- Fix housing to ground, add force distributing element, set damping ratio
- Reading load splines from the System Module

Data exchange from System Module to RecurDyn



The forced response calculation in the System Module generates the load data used to excite the housing modelled in RecurDyn

- Force vector for each bearing in time domain
- Speed sweep, user defined speed increments
- Export of text files from the System Module, import in RecurDyn using script

Results

Distribution of ERP over housing surfaces is as basis for predictive analysis of noise emitted.

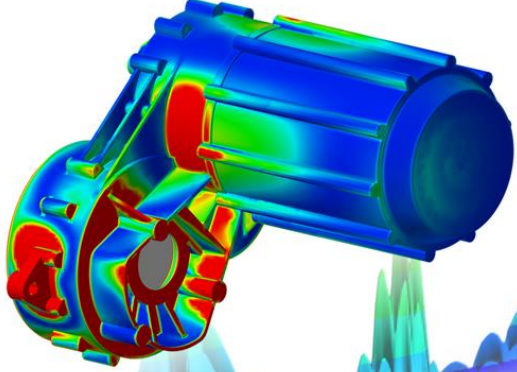
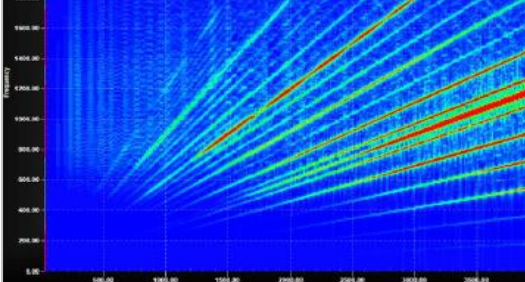
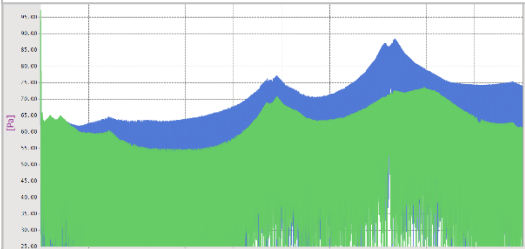
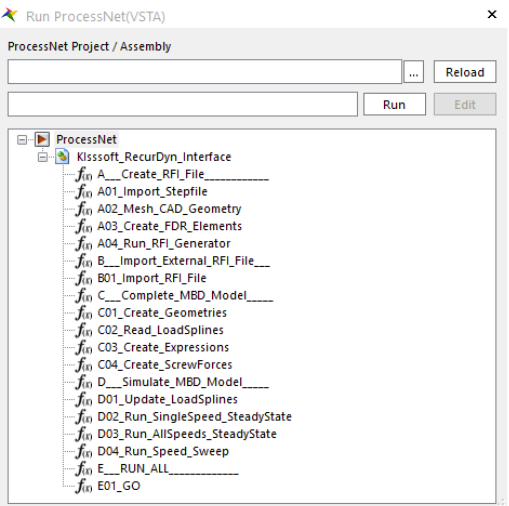
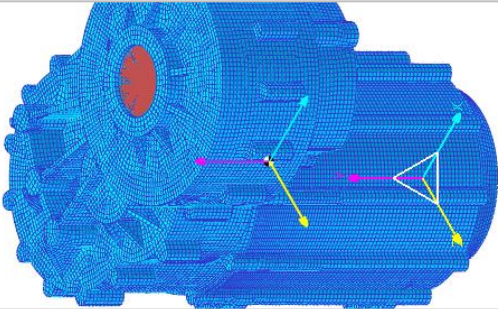
- Accelerometer evaluation
- ERP (effective radiated power) for structure borne noise assessment, in time and frequency domain
- SPL (sound pressure level) measured using virtual microphones
- NVH analysis for speed ramp, by interpolation between singular speed levels
- Campbell diagram 2D and 3D
- Evaluation of individual modes in time domain and frequency domain



The image displays the RecurDyn software interface and results. At the top is the RecurDyn logo with the tagline 'MBD 4 Professionals'. Below it is a 3D mesh model of a housing with coordinate axes. The middle section shows a screenshot of the 'Run ProcessNet(VSTA)' interface, which includes a project tree with functions such as 'A01_Import_Stepfile', 'A02_Mesh_CAD_Geometry', and 'E01_GO'. Below the interface are two plots: a stacked area chart showing ERP (dB) vs frequency (Hz) and a Campbell diagram showing frequency (Hz) vs speed (rpm). At the bottom is a 3D visualization of a housing with a color-coded ERP distribution.

Cylindrical gear basis modules

Configurations

- Spur and helical gear, double helical, herringbone, with or without face width offset
- Grease or oil lubricated or dry running gears
- Metallic and plastic gears
- Involute and non-involute gears
- Any number of teeth, any type of tooth height, internal or external gears
- Symmetrical and asymmetrical profile

Gear geometry calculation

- Gear geometry along ISO 21771, DIN 3960
- Reference profile along ISO 53, DIN 867, JIS B 1701, GOST 13755, DIN 3972, DIN 58400, BS 5482
- Tooth thickness tolerances along DIN 3967, ISO 1328, DIN 58405, GOST 1643
- Centre distance along ISO 286, DIN ISO 2768, DIN 7168, DIN 58405, GOST 1643
- Gear quality along ISO 1328, AGMA 2015, DIN 3961-3963, AGMA 2000, GOST 1643, JIS B 1702
- Own input

Gear rating

- DIN 3990 method B, DIN 3990 method B with YF along method C, DIN 3990 Part 41 (vehicles)
- ISO 6336:2006 and ISO 6336:2019
- Static rating against yield
- AGMA 2001-C95, AGMA 2101-D04, AGMA 2001-D04
- AGMA 6004-F88, AGMA 6011-J14, API 613 :2021, AGMA 6014-B15, AGMA 6015-A13, GOST 21354-87
- Plastic gears along Niemann, VDI 2545, VDI 2545 modified, VDI2736
- BV / Rina FREMM3.1, Rina 2010, DNV41.2, Loyds Register 2013
- ISO 13691:2001 (high speed gears)
- For nominal load or load spectrum

Reports

- Default report or user specific template
- Geometry and strength reports
- Tooth scuffing, micropitting and wear
- Tooth thickness dimensions, tooth tolerances
- Modifications, manufacturing
- X-Y coordinates of tooth profile

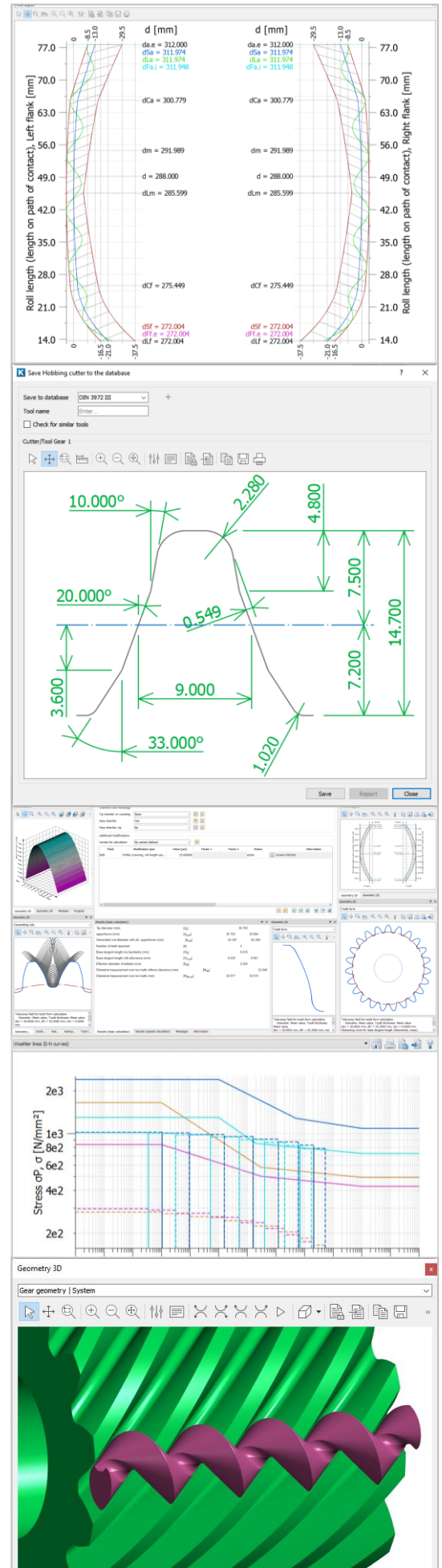

Cylindrical gear general modules

Gear geometry calculation

- Based on gear or tool reference profile with protuberance, buckling root, reference thickness, semi- non- full topping
- Or based on *.dxf import of tool geometry
- Calculation based on mating gear geometry
- Import and export of gear or tool geometry from CAD system
- Calculation of theoretical, acceptance and operating backlash for metallic and plastic gears and housings

Load spectrum calculation

- Direct input of load spectrum or import from text or Excel file or time series
- Calculation of lifetime based on required safety factor, safety factors based on required lifetime and permissible torque based on required safety factor and lifetime
- Calculation of partial damages
- Calculation of equivalent torque
- For DIN 3990, ISO 6336 and AGMA 2001 rating

AGMA925 calculations

- Calculation of scuffing safety
- Calculation of contact stress, lubricant film thickness

Micropitting and scuffing calculation

- Micropitting rating along ISO/TS 6336-22
- Specific lubricant film thickness calculation along AGMA 925
- Lubricant film thickness calculation along ISO/TS 6336-22 based on true contact stress
- Scuffing rating along ISO 6336-20, ISO 6336-21, DIN 3990-4

Flank fracture calculation

- Along ISO/TS 6336-4 method
- Along method A (based on LTCA) or method B (based on formulas)
- Case crushing calculation along DNV 41.2

Master gear calculation

- Calculation of master gear geometry
- Meshing of master gear with workpiece
- Sizing function for form diameters

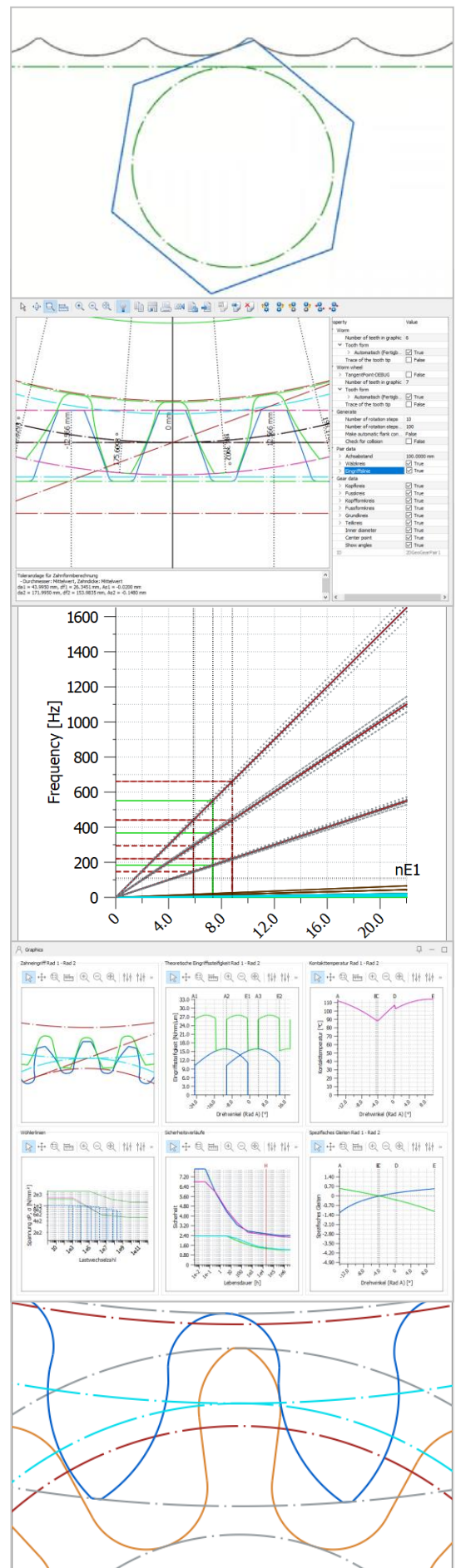

Cylindrical gear sizing modules

Configurations

- Sizing functions to find optimized gears (in terms of mass, power density, stiffness, space, ... requirements)
- Functions to reverse engineer gears
- Functions to optimize gear properties

Rough sizing

- Proposal of several gear solutions for required power rating, required ratio, given material
- Considers gear quality, permissible ratio error
- For single load level or load spectrum

Fine sizing

- Define permissible ranges for module, pressure angle, helix angle, center distance, face width, gear quality, profile shift, ...
- Define target ratio and permissible deviation
- Set maximum permissible tip diameter and minimum permissible root diameter
- For pre-defined number of teeth or varying number of teeth
- Different filter and sorting functions
- Report with assessment of solutions for different criteria

Profile shift sizing

- Sizing from gear pair data
- Sizing for target profile shift sum
- For balanced specific sliding / speed increaser
- To avoid pointed tooth or undercut
- For maximized strength on flank or root or maximized scuffing strength

Sizing of tooth height / reference profile

- Sizing of reference profile for target transverse contact ratio
- Sizing of maximum possible root radius

Sizing of profile and lead modifications

- Sizing of tip and root relief Sizing of end relief and crowning
- Automatic search for optimum modifications

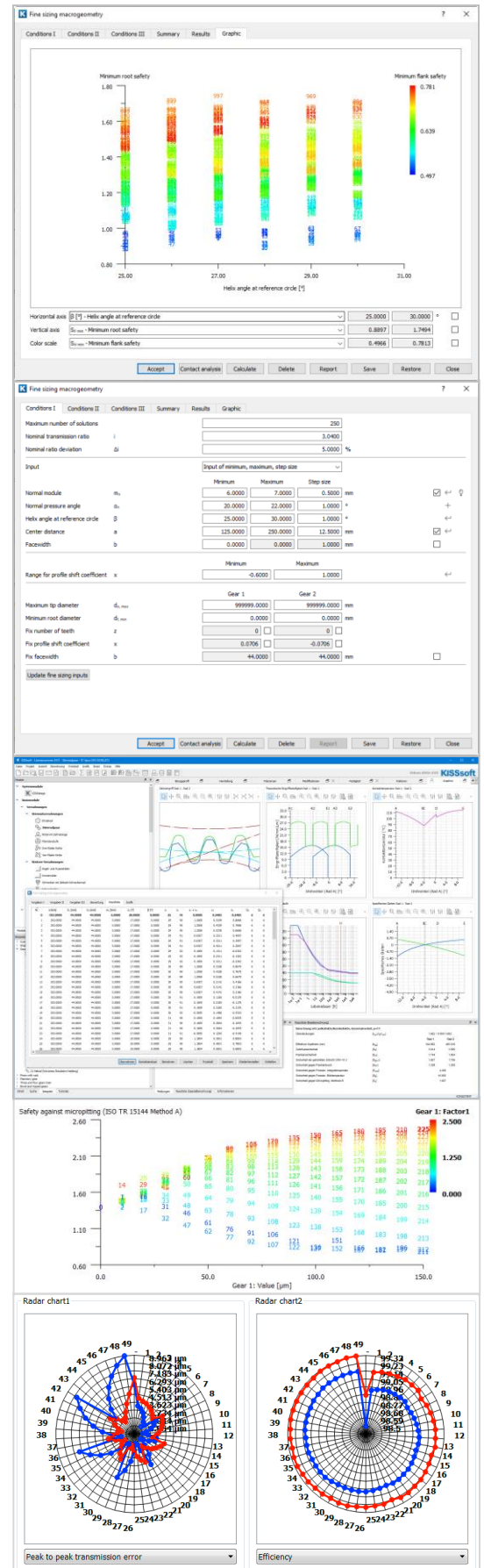

Cylindrical gear modifications

Configurations

- Combine modifications in profile and lead direction, combined and topological modifications
- Create K chart and lead diagram
- Define tolerances range based on AGMA 2000, using constant band width or import tolerance bands from GAMA ®
- Display each modification separately in 2D diagram, display resulting combination
- Show flank modifications in 3D, combining all modifications
- Gear 3D geometry includes modifications
- Tip chamfer, tip rounding in different sections
- Face chamfer, tip face chamfer
- Modifications manager using variants of sets of modifications

Root modifications

- Root with pre-machining and or final machining, independent root diameter tolerances
- Grinding notch, partial final machining of root
- Root geometry optimization for minimized root stresses

Manufacturing errors as modifications

- Flank waviness with wavelength, amplitude and angle
- Natural twist from generating grinding
- Profile and helix form and slope deviation

Lead and profile modifications

- End relief (left and right end), flank line crowning (central, eccentric)
- Helix angle modification
- Linear and progressive tip / root modification
- Profile crowning (barreling), also in combination with tip relief, roll length or diameter centered
- Pressure angle modification
- Tip chamfer or rounding
- Flank twist
- Triangular end relief (left and right end)
- Topological modification
- ...

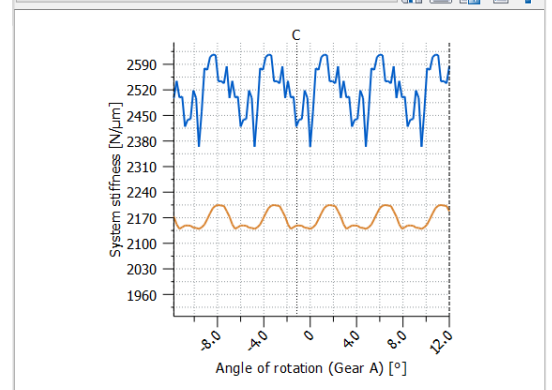
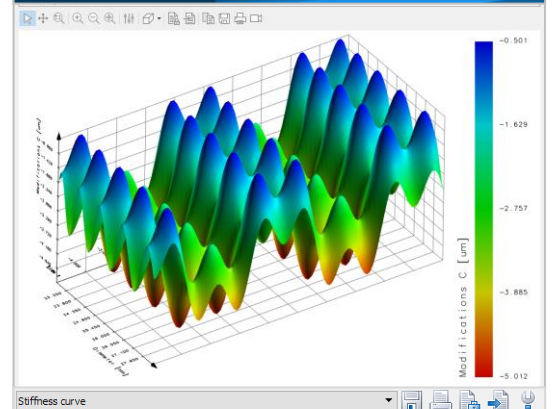
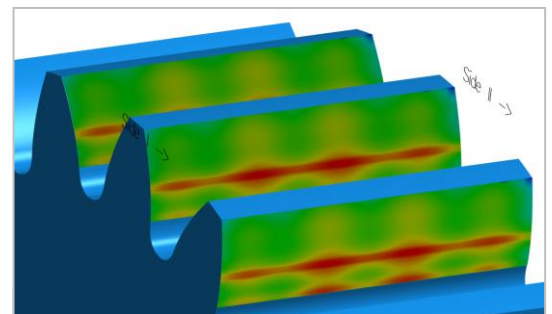
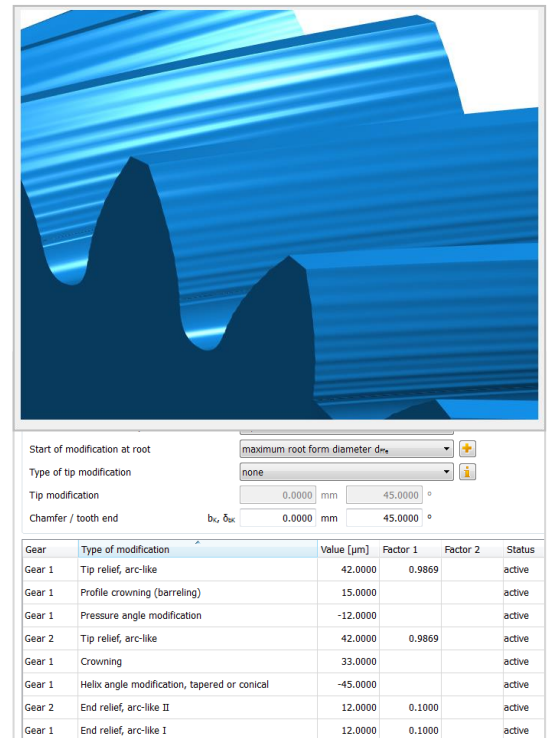

Gear body influence

Modelling and FEM

- Hub / web / rim arrangement
- Parametrized geometry
- Automatic meshing, parabolic tet elements
- Automatic meshing, parabolic prism elements
- Modeling of local radii
- Automatic defeaturing capabilities
- Geometry preview, mesh preview
- Import of *.stp files
- Multibody modelling (separate materials for rim and body)
- Result review per body

Calculations and integration

- Calculation of deformation and reduced stiffness matrix
- Stiffness matrix connected to shaft calculation
- In combination with LTCA
- 2D and 3D-gear body deformation

Tooth geometry export

Options

- With or without profile / lead modifications
- Modifications may be different per tooth
- Modifications may be different per flank
- Output in transverse, normal and axial section
- Output of tooth or gap, single or half tooth
- Output as x,y format to use e.g., in spreadsheet calculations
- Output as x, y, z format in line with Gleason or Klingelnberg format for measuring machines

Rating with time series

Import and conversion

- Import time series of speed and torque from text file
- Convert to load duration distribution load spectrum (LDD), save LDD for gear rating
- Considers changes in torque direction
- Considers changes in speed direction
- Graphical display of resulting load and speed distribution

Configurations

- Rain flow count method according to Amzallag or ASME
- Simple count method

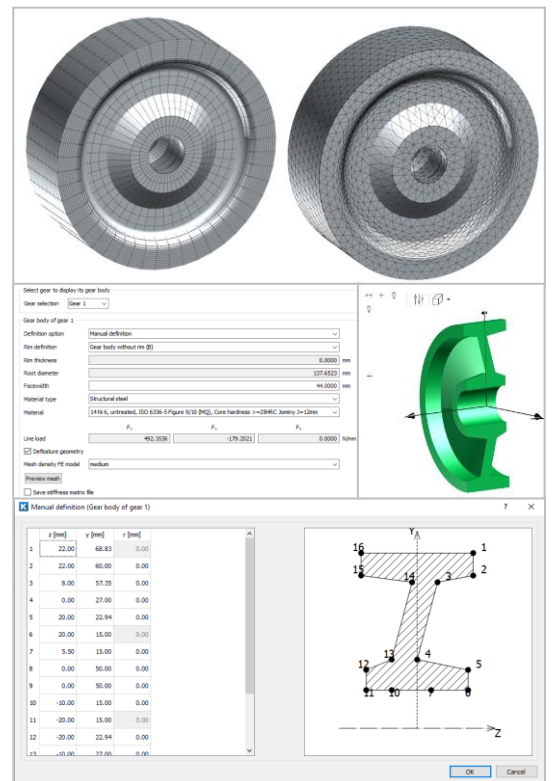

```

* PART # : 0.000.0          NUMBER OF TEETH % Z ! 25          *
*                          THEORETICAL 04/03/2020          *
* DIFF. ANG : % DEDI ! -6.7371    REF. PT.: ! (14, 10)    *
*-----*-----*
* NUMBER COLUMNS : ! 27          NUMBER LINES : ! 19          *
*-----*-----*
* DATE : 04/03/2020          TIME : 08:27:52          UNITS : mm          *
*-----*-----*
* J  I   X       Y       Z       XN       YN       ZN          *
*-----*-----*
1  1   -72.4733  -1.5141  20.4286  -0.2136  -0.9769  -0.0000
1  2   -72.9744  -1.3968  20.4286  -0.2415  -0.9704  -0.0000
1  3   -73.4756  -1.2650  20.4286  -0.2667  -0.9638  -0.0000
1  4   -73.9768  -1.1197  20.4286  -0.2898  -0.9571  -0.0000
1  5   -74.4777  -0.9618  20.4286  -0.3113  -0.9503  -0.0000
1  6   -74.9785  -0.7917  20.4286  -0.3315  -0.9435  -0.0000
    
```

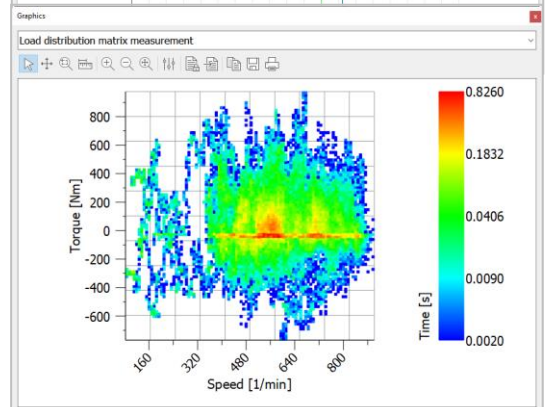
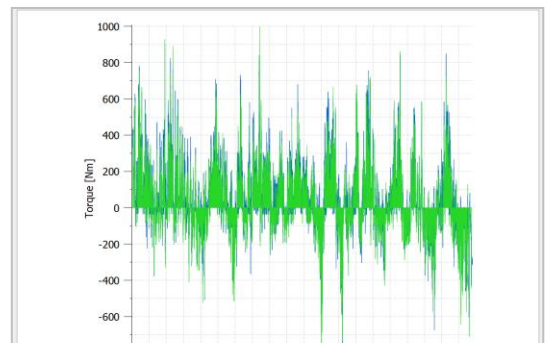

Loaded tooth contact analysis

Configurations

- Considers all modifications in profile and lead direction and topological modifications
- Calculation over one or several pitches
- Pitch errors may be considered in part or fully
- Calculation for nominal or operating center distance
- Calculation for nominal or partial load level
- Meshing friction considered in calculation
- Considers true gear geometry from manufacturing simulation
- For internal and external gears
- User defined resolution in calculation
- Line load calculation along ISO 6336-1, Annex E with consideration of manufacturing errors

Mesh stiffness calculation

- Calculation of transmission error TE for spur and helical gears, showing peak to peak transmission error PPTTE, average and standard deviation
- Calculation of normal force, torque variation, contact stiffness, bearing forces, kinematics, specific sliding, and local heat generated over meshing cycle
- Results displayed vs. roll angle, pinion diameter, length on path of action, pinion angle of rotation
- Calculation has been verified in benchmarks against reference software, practical experience in full load tests and FEM calculations
- Different methods for slice linking spring stiffness

Output

- Graphics, exportable as graphic format or *.dxf
- Report including calculation settings and results summary
- Report including all graphics

True contact ratio calculation

- Calculation of true transverse contact ratio under load
- Calculation of true total contact ratio under load

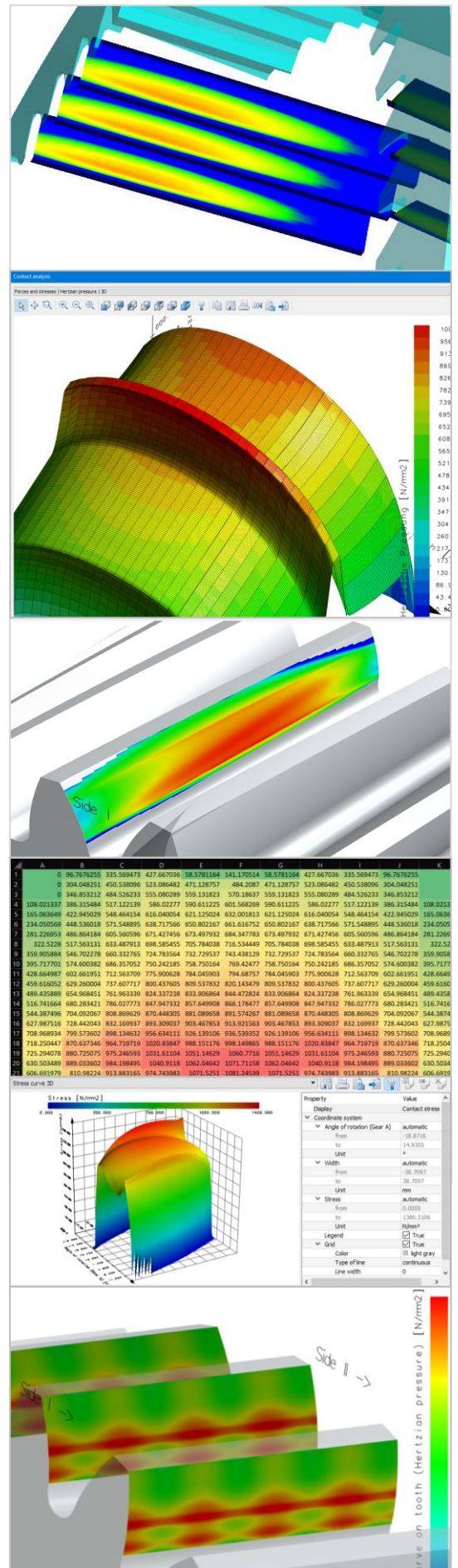

Detailed backlash calculation

Backlash from true tooth form

- Backlash is calculated as an angular backlash.
- Theoretical backlash is calculated based on true tooth form. Tooth form may be involute, involute with modifications or non-involute. For non-involute tooth form or involute tooth form with modifications, backlash is not constant over the meshing cycle.
- Backlash is calculated for highest, lowest and mean tooth thickness / diameter / center distance combination, resulting in three curves.
- Collisions and tip to root interferences are indicated by zero backlash condition
- Gear modifications in lead direction are considered, backlash is calculated for a number of slices along the face width
- Tooth deformation and temperature influence are not considered
- Works also for tooth form from imported *.dxf files

Backlash, acceptance backlash, operating backlash

- Theoretical backlash in transverse and normal section, chordal and arc value, considering tooth thickness and center distance tolerances.
- Acceptance backlash considering runout, manufacturing errors and axis misalignment.
- Operating backlash considering housing and gear temperatures and moisture absorption.
- Contact and collision check in 2D graphic in transverse section for any tooth thickness, diameter and center distance tolerance combination.
- Recommendation of tooth thickness tolerances in case of gear jamming.
- Backlash definition through manufacturing profile shift or tooth thickness tolerances.
- Calculation of tooth thickness / backlash from span measurement or from diameter over pins.
- Strength calculation on theoretical gear or on gear with backlash.

Theoretical backlash (Operating pitch circle)

- Circumferential backlash			
(min.)	(mm)	[tw.i]	0.213
(max.)	(mm)	[tw.e]	0.347

Acceptance-backlash

- Circumferential backlash			
(min.)	(mm)	[twa.i]	0.191
(max.)	(mm)	[twa.e]	0.325

Lowest operating backlash

- Temperature combination			
Gear body temperature	(°C)	[TR]	50.00
Case body temperature	(°C)	[TC]	30.00
- Circumferential backlash			
(min.)	(mm)	[twop.i]	-0.066
(max.)	(mm)	[twop.e]	0.068

2D FEM of virtual spur gear

FEM models

- 2D plane stress model using parabolic triangular elements with variable mesh density
- Mesh density is maximized for critical area in the root
- Resulting stress levels are calculated for contact point of 30° (60°) tangent to theoretical tooth form, for contact point of 30° (60°) tangent to actual tooth form and for point with highest stress
- Stress levels are reported and compared to nominal stress calculated along ISO 6336
- FEM pre-processor (Salome) and solver (Code Aster) are remote controlled requiring no interaction.
- Pre- and post-processor may be opened after calculation to check mesh, boundary condition and results
- Different stress values like von Mises, max and min principal and others may be shown. Different color bars may be used.

Root stress calculation

- For standard gear geometry with trochoidal fillet based on circular tip of tool
- For non-standard gear root geometry including machining notches / grinding notches
- For non-trochoidal, e.g., circular, or elliptic root shape
- Also, for cycloidal and circle shaped (non-involute) gears
- For asymmetrical involute gears

3 FEM

FEM model

- For spur and helical gears
- Using parabolic tetraeder elements

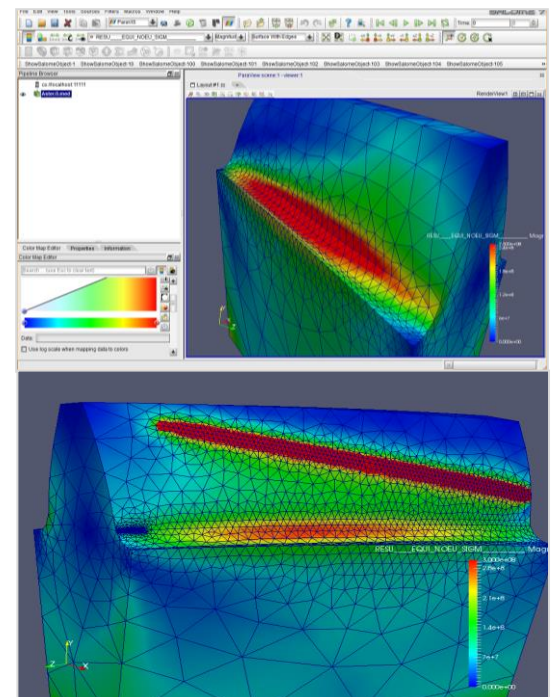
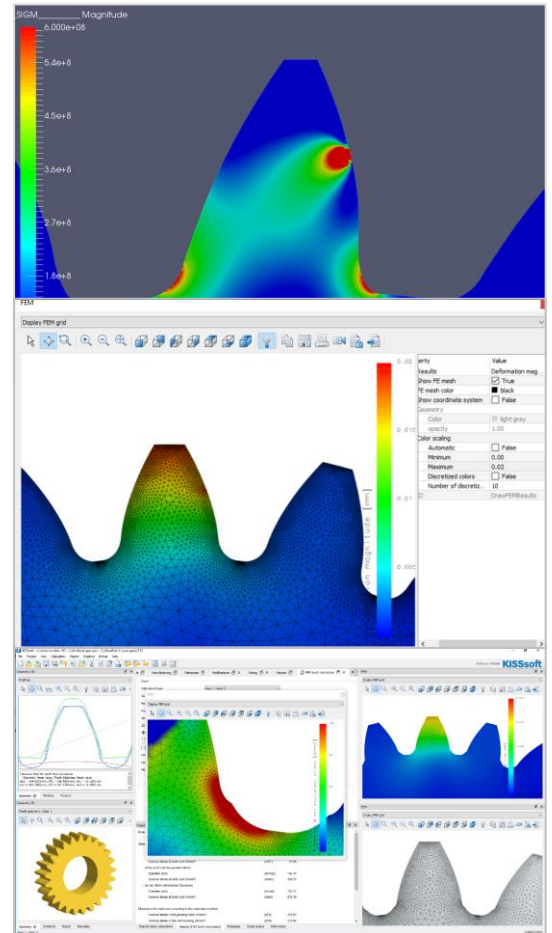

Planetary gears

Overview

- Based on helical gear calculation modules
- Calculation of planet pin location for non-evenly spaced planets
- Influence of rim thickness of ring gear and planet gears considered
- Assembly check
- Sizing function for load distribution factor along AGMA 6123
- Rough and fine sizing function

Strength rating, planets

- DIN 3990 method B, DIN 3990 method B with YF along method C, DIN 3990 Part 41 (vehicles)
- ISO 6336:2006 and ISO 6336:2019
- Static rating against yield
- AGMA 2001-C95, AGMA 2101-D04, AGMA 2001-D04
- AGMA 6004-F88, AGMA 6011-J14, API 613 :2021, AGMA 6014-B15, AGMA 6015-A13, GOST 21354-87
- Plastic gears along Niemann, VDI 2545, VDI 2545 modified, VDI2736
- BV / Rina FREMM3.1, Rina 2010, DNV41.2, Loyds Register 2013
- ISO 13691:2001 (high speed gears)
- For nominal load or load spectrum
- Planet system reliability
- Micropitting rating along ISO/TS 6336-22, scuffing rating along ISO 6336-20, ISO 6336-21, DIN 3990, AGMA 925
- Flank fracture rating along ISO/TS 6336-4 and case crushing rating along DNV 41.2

Ky calculation

- For systems with perfect pin position or for pins with positioning error
- Quasi-static load distribution neglecting dynamic effects
- Sun may be floating or stationary
- K_y is calculated for momentary force equilibrium for different meshing positions
- Considering system equilibrium for in-phase and out-of-phase systems
- Phasing check

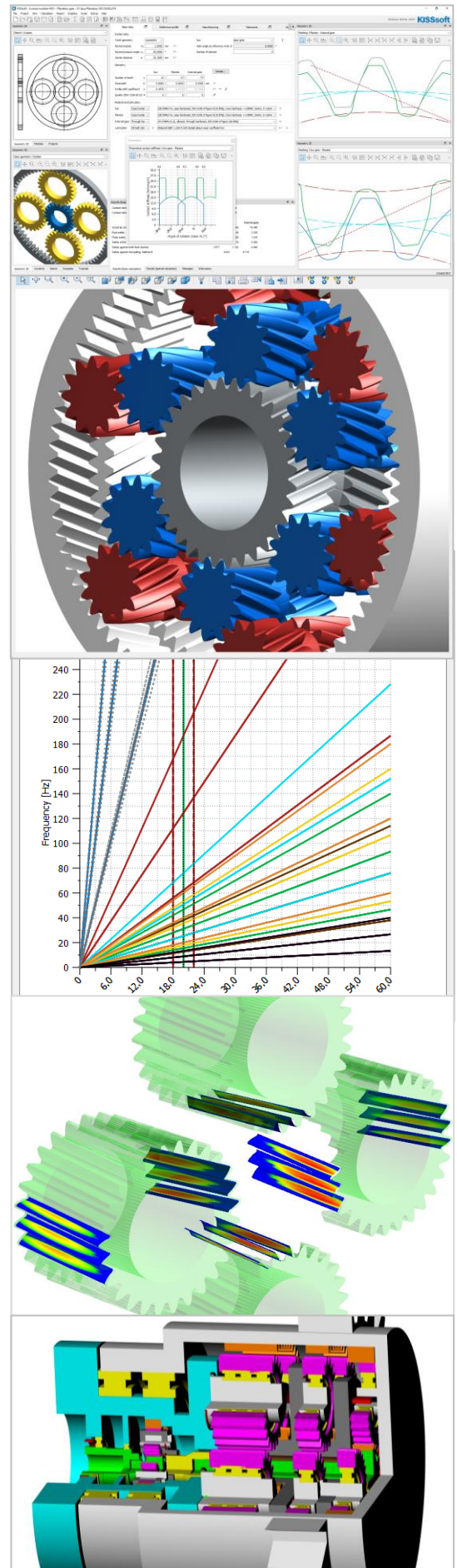

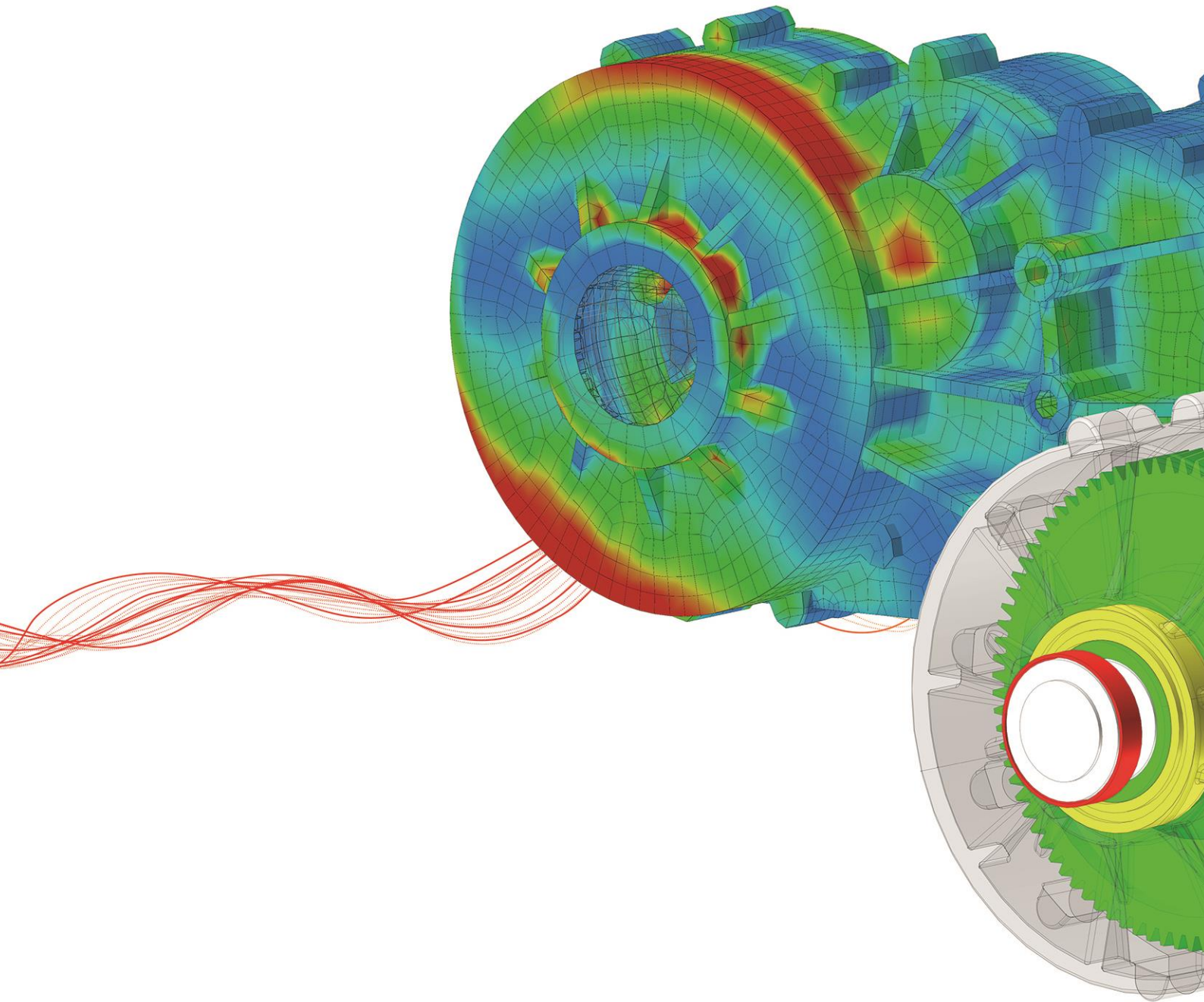

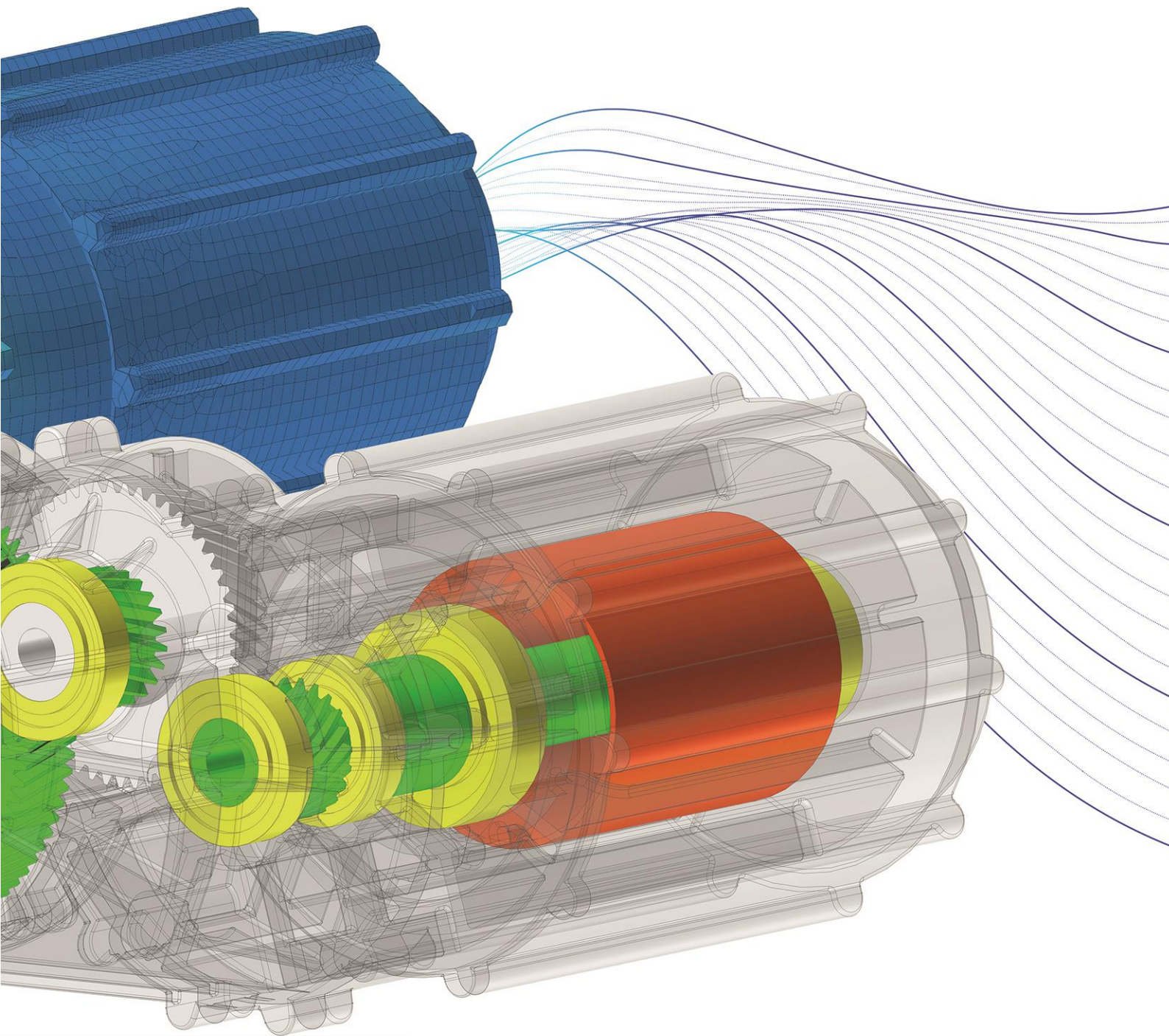

Planetary tooth contact analysis

FEM calculation of planetary carrier

- Planetary carrier torsion is calculated inside KISSsoft with FEM
- Salome / Code Aster is used as pre-processor and solver, using Python scripts
- Based on parameterized model of the carrier (import of carrier geometry is not directly possible)
- Mesh generation is automatic
- Includes sizing function for planetary carrier geometry
- Results may also be directly imported from FEM results file

Ring gear deformation

- In case of ring gears supported only on one side, the conical deformation may be considered for the planet – ring gear mesh

Sun gear arrangement

- Floating or fixed sun gear
- In case of floating sun gear, quasistatic momentary equilibrium is calculated

Link to shaft calculations

- Planetary carrier tilting in carrier bearings or due to manufacturing errors may be considered from shaft calculation
- Sun shaft twist, sun shaft tilting may be considered in LTCA with planets
- Planet pin deformation and planet bearing deformations is automatically imported from shaft calculation
- Planetary tooth contact analysis may be integrated into System Module models

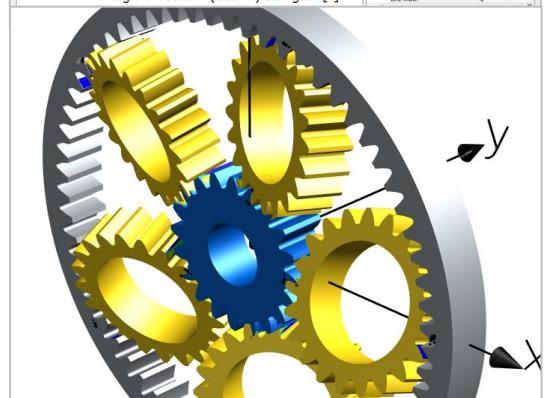
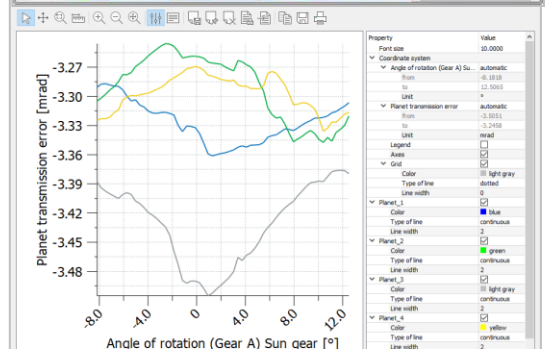
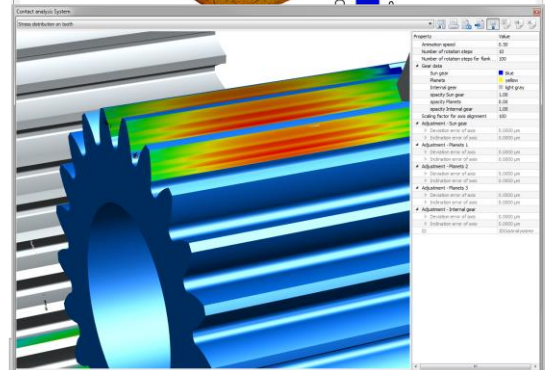
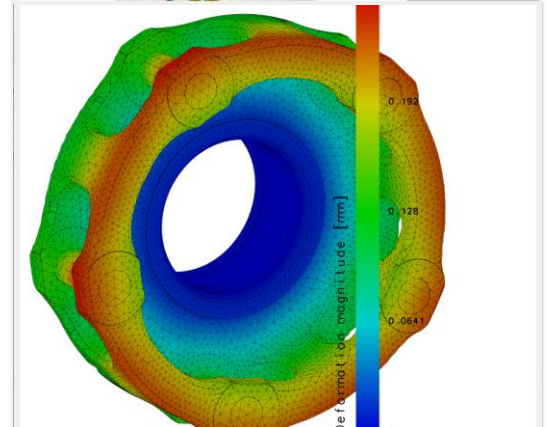
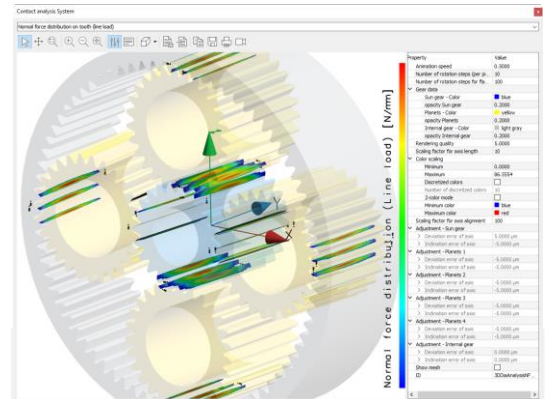

Rack and pinion modules

Strength rating

- DIN 3990 method B, DIN 3990 method B with YF along method C, DIN 3990 Part 41 (vehicles)
- ISO 6336:2006 and ISO 6336:2019
- Static rating against yield
- AGMA 2001-C95, AGMA 2101-D04, AGMA 2001-D04
- AGMA 6004-F88, AGMA 6011-J14, API 613 :2021, AGMA 6014-B15, AGMA 6015-A13, GOST 21354-87
- Plastic gears along Niemann, VDI 2545, VDI 2545 modified, VDI2736
- BV / Rina FREMM3.1, Rina 2010, DNV41.2, Loyds Register 2013
- ISO 13691:2001 (high speed gears)
- For nominal load or load spectrum
- Micropitting rating along ISO/TS 6336-22, scuffing rating along ISO 6336-20, ISO 6336-21, DIN 3990, AGMA 925
- Flank fracture rating along ISO/TS 6336-4 and case crushing rating along DNV 41.2

Output

- Reports for manufacturing tolerances, drawing data, hardness depth proposal, geometry calculations and strength rating
- Life and strength results
- 2D and 3D gear geometry

Crossed axis rack and pinion

- Axis angle $\neq 0^\circ$
- Calculation of contact ellipse size
- Stress calculation, strength rating
- No load contact pattern
- Consider pinion lead and profile modifications
- Export of 3D geometry in neutral format

Elliptical gears

Mesh calculation for wave gears

Geometry

- Definition of elliptical external gear
- Definition of circular internal gear
- With low number of teeth difference
- Graphical representation of mesh

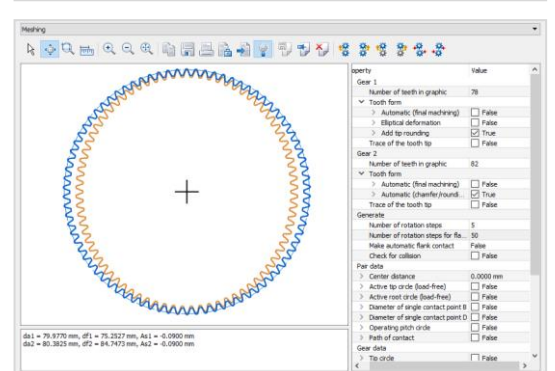
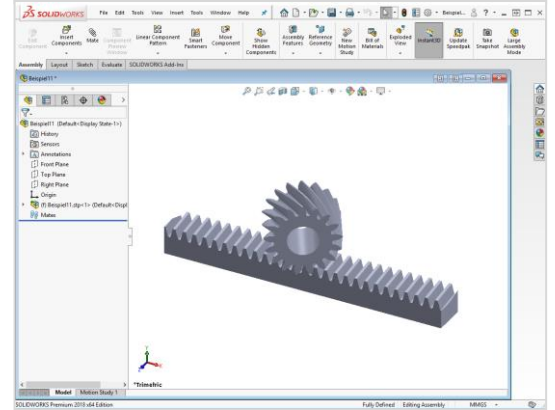
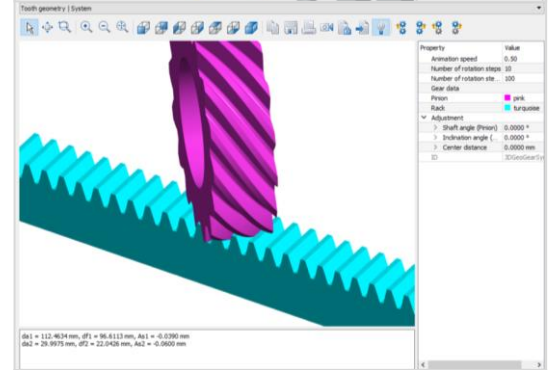
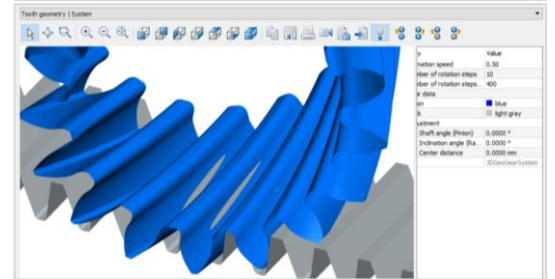
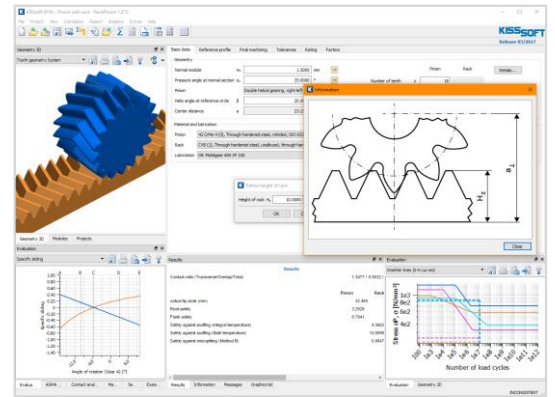

Asymmetrical teeth, cylindrical gears

General

- Strength rating along ISO 6336, VDI 2545 and VDI 2736 for left and right flank / root
- Different pressure angle and root rounding for left and right side
- Face width offset may be positive or negative
- 3D models include solid model, skin model, cutting model
- Calculation of subsystem reliability based on pinion and gear life, using three parametric Weibull distribution

Configurations

- Spur, helical, double helical
- Gear pair calculation where pinion is driving or driven
- Rack and pinion, chain of three gears, chain of four gears
- Planetary gears consisting of sun, planet and ring gear, with any possible number of planets
- Export of 2D or 3D geometry considering tolerances such as tooth thickness tolerances, tip and root diameter tolerances
- Gear modifications in lead and profile direction

Features

- Export of 3D geometry or of 2D geometry
- Allows for LTCA in loaded tooth contact analysis module
- No load contact analysis (intersection of skin models)
- Loaded tooth contact analysis for both flanks considering shaft misalignment and modifications
- Lead and profile modifications may be applied differently for left and right flank.

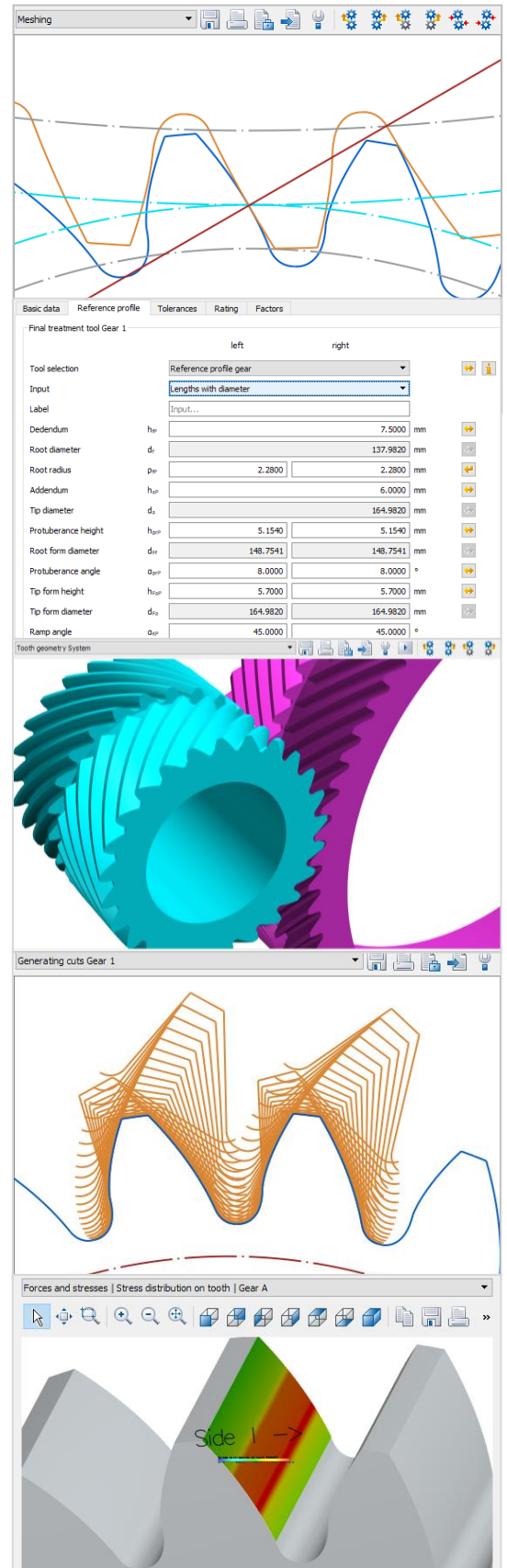

Non-circular gears

Non-circular gears can be calculated in KISSsoft based on an operating pitch curve. Gears may be closed or open.

Design of geometry

- Required momentary ratio may be defined
- Required meshing curve may be defined

From there, the following is calculated

- Calculation of meshing curve from momentary ratio
- Calculation of shaping cutter from gear / tooth data
- Calculation of backlash such that no jamming occurs
- Calculation of non-circular gear contour
- Export to CAD with different levels of accuracy (up to 800 points per flank)
- Add tip rounding
- Modify root geometry to increase strength
- Check of meshing / collisions in 2D
- Calculation of position of rolls for dimension over rolls measuring

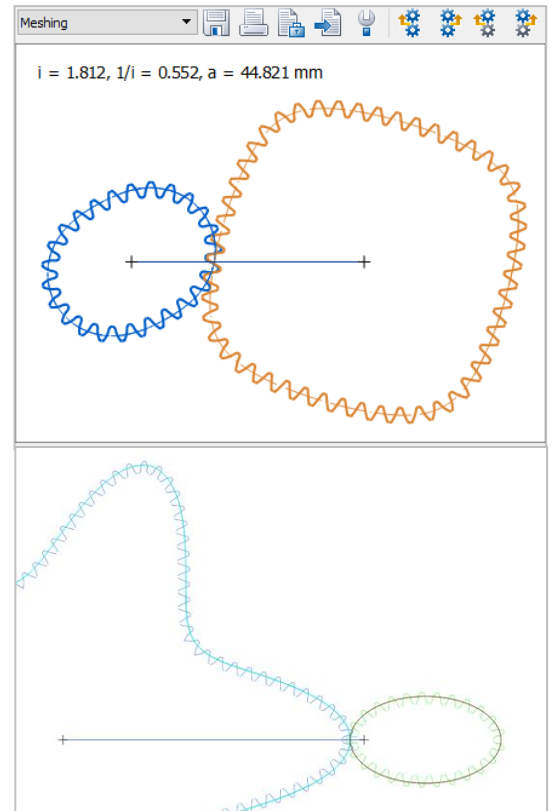

Beveloid gears

Beveloid gears (conical gears) can be modelled and rated in KISSsoft for small shaft and cone angles

Calculations, geometry and strength

- Cone angle on both gears may be different
- Considers shaft and cone angles
- Spur and helical gears
- Includes micro geometry model
- Strength rating as per DIN, ISO, AGMA
- Based on equivalent cylindrical gear
- No load tooth contact analysis

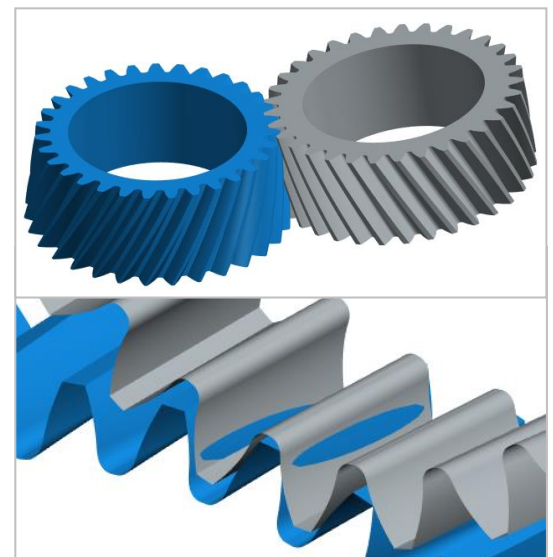

Double planet

- Assembly condition and collision check
- Strength rating as for cylindrical gear modules
- 2D and 3D geometry

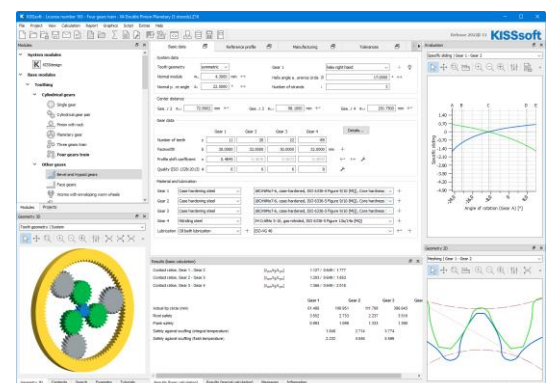

Bevel gear modules

General

- Strength, life and reliability rating for nominal load and load spectrum
- Database for reference profile and tolerances
- Different geometry configurations with uniform tooth depth, constant slot width, modified slot width, different root and tip apex positions
- For spur, helical, zerol or spiral bevel gears
- Rough and fine sizing function, fine sizing function for modifications
- Calculation of measurement grid for Klingelnberg, Gleason or Zeiss gear tester

Strength rating

- Strength rating along ISO 10300, DIN 3991, AGMA 2003, KN3028 / KN3030 for Cyclo-Palloid gears and along KN3025 / KN3030 for Palloid gears
- Hypoid gear calculation along KN3029 / KN3030 for Cyclo-Palloid gears, KN3026 for Palloid gears, ISO 10300
- Plastic gear rating along VDI 2545 or Niemann, static strength rating and rating of differential planetary gears
- Efficiency along Wech, Niemann, ISO/TS 1300-20
- Flank breakage calculation along ISO/DTS 10300-4
- Scuffing rating along DIN 3990-4, ISO/TS 6336-20, ISO/TS 6336-21, ISO/TS 10300-21

Manufacturing

- For face hobbled or face milled gears
- Considering Klingelnberg machine list
- Accurate 3D gear geometry for CNC machining, based on planar involute geometry
- No load tooth contact analysis considering lead and profile modifications

No load tooth contact

- Calculated of loaded tooth contact with low load
- Considers all gear modifications
- Direct input of misalignment values
- For verification of contact patterns after manufacturing

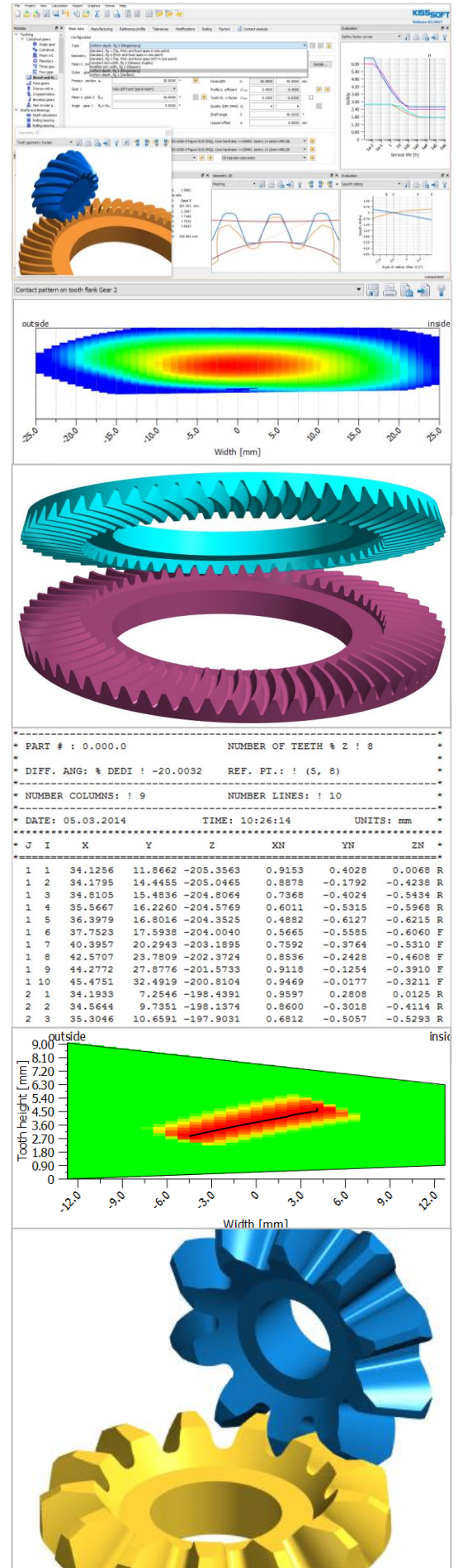

Loaded tooth contact analysis

- LTCA of spur, helical and spiral bevel gears
- For nominal load or with consideration of KA and Kv and for load spectrum
- Using slice model
- Line load distribution over whole face width (contact pattern under load)
- Momentary line load distribution as contact lines for different mesh positions

Bevel gear transmission error

- Loaded or non-loaded (lightly loaded) TE
- PPTe values
- FFT of transmission error

Further load distribution-based results

- Flash and contact temperature
- Scuffing safety factor
- Flank fracture safety factor
- Micropitting (adapted from cylindrical gear calculation)

Contact for misaligned systems

- Input of HGV misalignment
- Input of shaft angle deviation
- For drive and coast side
- Considering housing, bearing and shaft deformation

Tooth flank fracture calculation

- Calculated hardness distribution
- Hardness distribution input from measurements
- Calculation along ISO/DTS 6336-4 and Annast

Differential gears

- Fine sizing of differential gears
- LTCA for spur gears with modifications

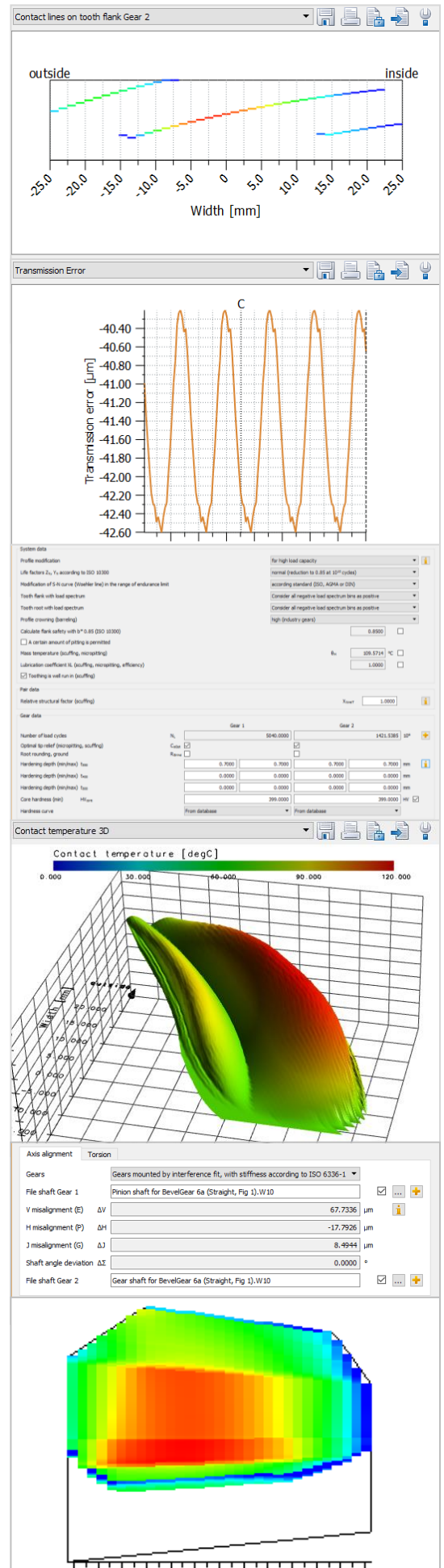

Worm gear modules

General

- For ZC, ZI, ZA, ZN, ZK, ZH geometry
- Includes rough and fine sizing function
- Accurate 3D geometry

Strength rating

- Based on E DIN 3996:2012, DIN 3996:1998, ISO/TR 14521:2010, AGMA 6034, AGMA 6135
- No load contact analysis

System data

- Considers drive direction, bearing power loss, seal loss, permissible wear
- Considers cooling through housing and lubricant and running time

Chain of gears / idler gears

Configurations

- Three gear chain with one idler gear
- Four gear chain with two idlers
- Input on first and output on last gear
- Alternating bending is considered on idler
- Definition of two or three center distances

Calculations

- Same calculations as for gear pair and planetary gears
- Independent hardness definitions
- ISO 6336-3, Annex B mean stress influence
- Fine sizing function
- Calculation as double planet for several strands
- Definition of fourth gear in the chain as internal gear
- Including assembly condition and collision check

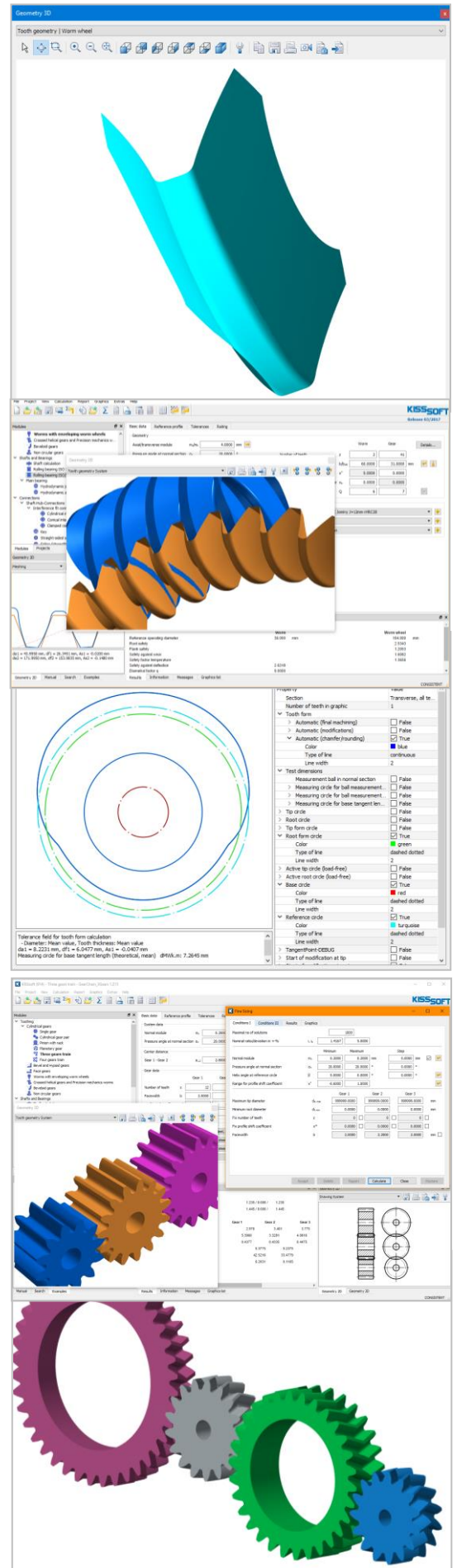

Crossed axis helical gear

General

- Strength rating along ISO 6336 (modified along Niemann), along Hoechst for worm gears and along Hirn for worm gears. For plastic gears along VDI 2545 and VDI 2736
- Calculation of theoretical backlash, acceptance, and operating backlash
- Calculation of flank, root and scuffing safety factor with single load or load spectrum
- Output of control measures like dimension over pins and balls
- With rough and fine sizing function

Configurations

- For plastic and metallic materials
- Calculation with lead or helix angle
- Calculation of meshing efficiency
- For worm type or helical gear type mesh (any helix angle)
- Tooth form calculation with modifications like tip and root relief, chamfer, tip rounding, elliptic root rounding for improved noise and strength properties

Gear pumps

General

- For involute and non-involute tooth shape
- For external or internal gear pumps
- Calculation of tooth form, tooth load and volume flow
- Nominal flow calculation or considering elastic deformation of teeth
- Flow calculation can be combined with sizing functions

Expert options

- Changes in important parameters of pump during contact are calculated
- Includes enclosed volume, the volume with critical in-flow, narrowest point between flanks of first tooth pair not engaging marking the boundary of critical in-flow area, in flow velocity, oil flow, Fourier analysis for evaluation of noise potential, and total volume under entry chamber pressure

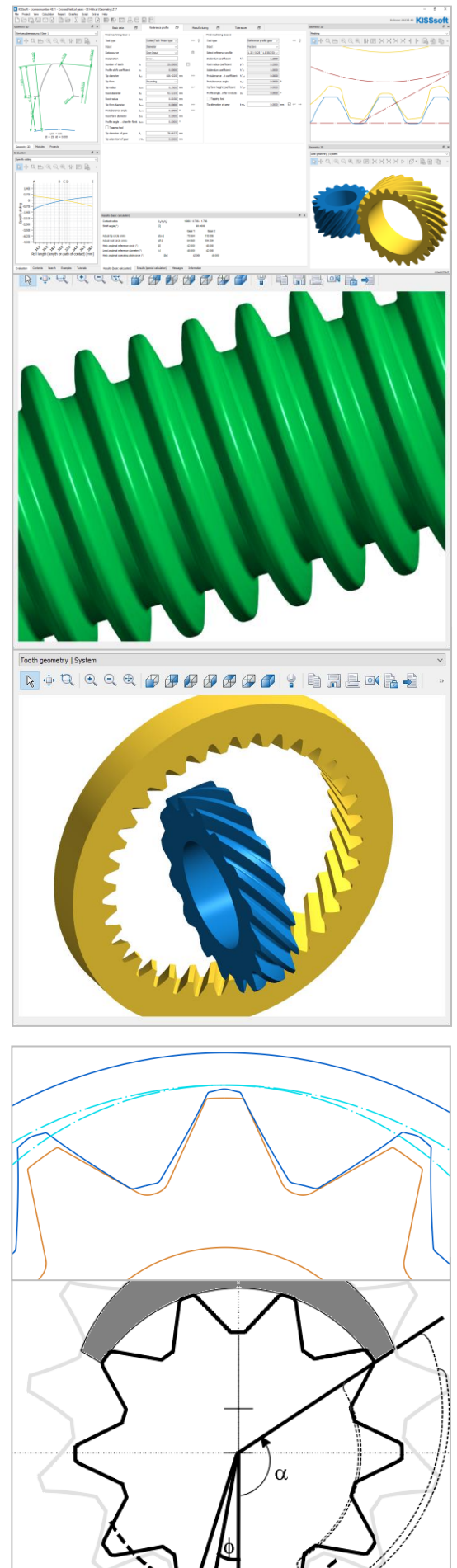

Face gears

General

- Strength rating along ISO 6336 (modified along Niemann, Roth and Basstein), ASS / Crown Gear / DIN 3990, based on ISO 10300, based on DIN 3991
- For 90° or greater shaft angle, with axis offset, for spur and helical gears
- Axis offset may be positive or negative
- 3D models include solid model, skin model, cutting model (based on shaping cutter geometry) and solid model of single tooth and single gap of face gear
- Calculation of subsystem reliability based on pinion and face gear life, using three parametric Weibull distribution

Configurations

- Face gear with cylindrical pinion as spur or helical gear
- Calculation of face gear geometry at different diameters by simulating manufacturing with a pinion type cutter
- Check against undercut and pointed tooth by varying tooth height
- Export of 2D or 3D geometry considering tolerances such as tooth thickness tolerances, tip and root diameter tolerances
- Crowning of face gear through modifications on pinion type cutter
- Output of contact lines on face gear
- Corner modification on inner and outer diameter

Export

- Export of 3D geometry of pinion, face gear and system as *.stp file
- Export of 2D geometry of pinion, shaping cutter and face gear sections as *.dxf file
- Export of surface topology / measurement grid using Klingelnberg and Gleason data format, for pinion and face gear, for a user defined number of grid points
- Export of pinion and face gear data table for CAD drawings

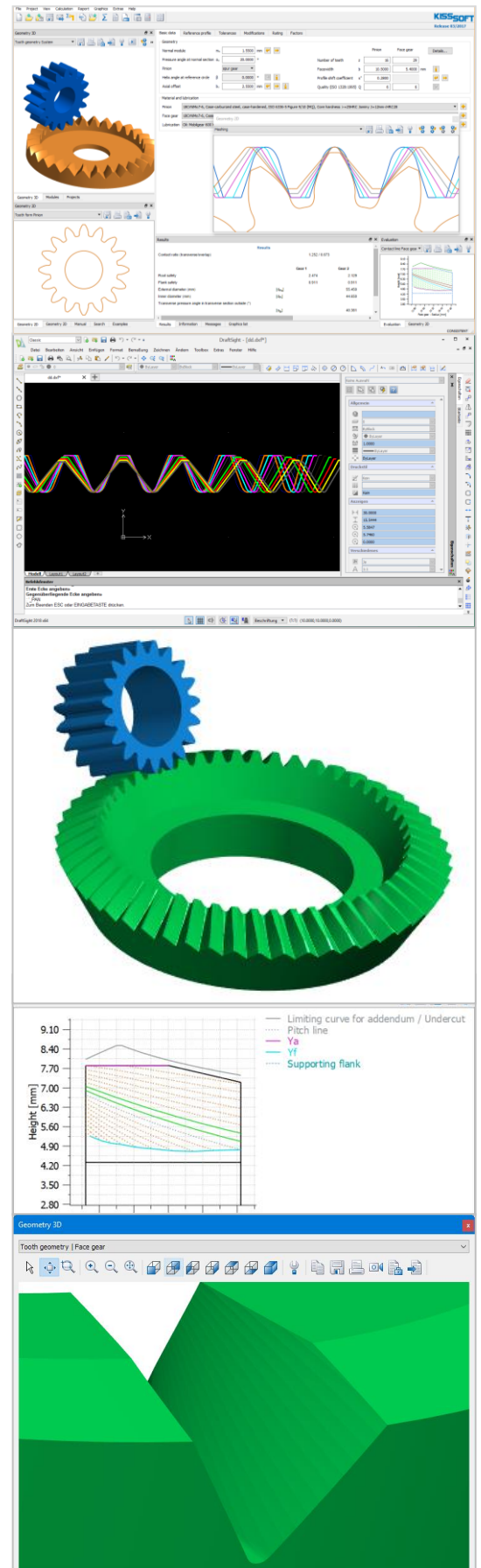

Shafts, coaxial shaft systems

General

- Graphical shaft editor for fast modelling
- Calculates stress concentrations from feature geometry
- Add force elements like gears, pulleys or couplings for simple load definition
- Materials, bearings, lubricants databases
- Automatic identification of critical sections

Configurations

- Single shaft or coaxial shaft systems
- Static deformation, modal analysis
- General supports or rolling element bearings, pilot bearings, internal bearings
- Linear or non-linear calculation with Euler or Timoshenko beam model considering temperature effects

Strength rating

- Strength rating along DIN 743, FKM guideline, Hänchen & Decker or AGMA 6101
- For static and fatigue strength, for single load case or load spectrum
- Using material database or own definition for S-N curve, different Miner rules
- Independent load factors and stress ratios for static and fatigue rating

Modal and forced response analysis

- Modal analysis
- Forced response analysis, with damping
- Considers bearing stiffness

Deformation and stiffness calculation

- Non-linear bearing stiffness is calculated based on inner bearing geometry
- Housing deformation, machining errors and similar may be defined as initial bearing offset
- Any number of loads may be added

Tooth trace calculation

- Calculation of shaft deformation of pinion shaft, calculation of necessary lead modification
- Housing stiffness, bearing stiffness and shaft stiffness may be considered

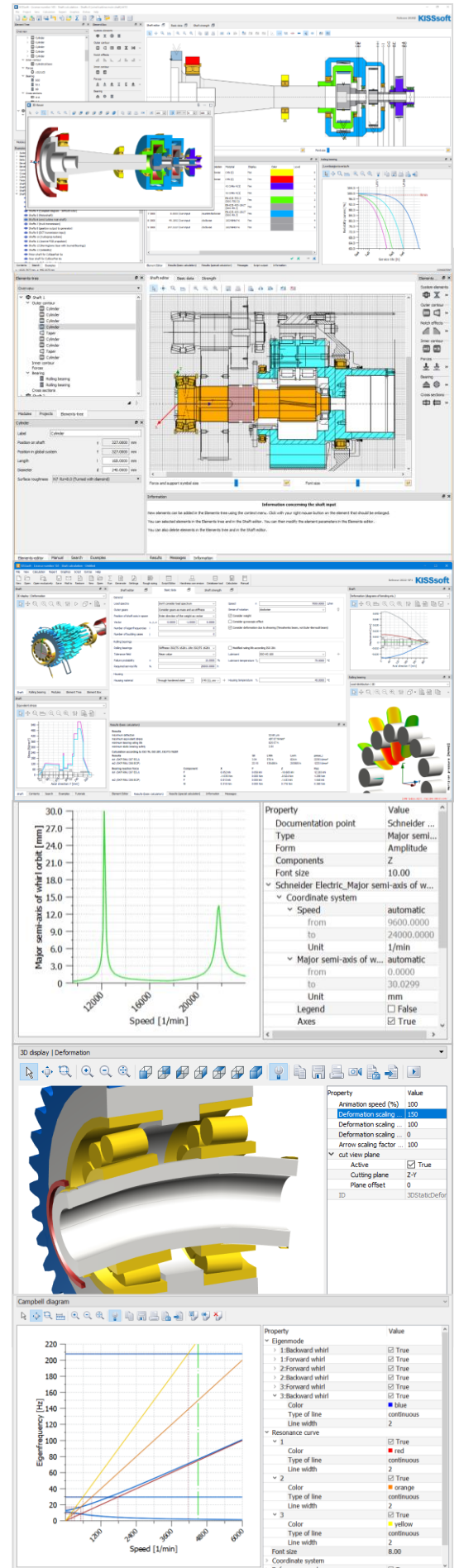

Bearings Configuration

- Calculation of single bearing or bearing-shaft system, any number of bearings in system
- With single load or load spectrum
- Sizing function for bearing selection

Bearing life rating

- Basic rating using load capacity numbers
- Modified rating considering lubricant properties
- Reference rating considering load distribution
- Modified reference rating
- Along ISO 281, ISO/TS 16281, ISO 76

Bearing stiffness and clearance

- Based on bearing inner geometry
- Shaft-bearing interaction for shaft and bearing systems
- Considers operating clearance / pre-tension
- Considers bearing, shaft, hub tolerances

Load distribution calculation

- Load distribution among rolling elements
- Contact stresses for balls
- Contact stresses for rollers, considering roller geometry modification (logarithmic)
- Contact stress distribution on raceway

Thermal rating

- Along DIN 732

Bearing database

- Bearing data from different bearing suppliers
- For different bearing types
- Basic bearing properties
- Bearing inner geometry, user editable
- Separate database for lubricants, lubricant purity definitions along ISO 4406

Hydrodynamic bearings

- Axial bearings DIN 31653, ISO 12130, DIN 31654
- Radial bearings ISO 7902, DIN 31652, DIN 31657, Niemann and Spiegel for grease lubricated bearings

The screenshot displays the SKF software interface, which is used for bearing calculations and analysis. It is divided into several sections:

- Configuration (Top):** This section allows users to set various parameters for the calculation, including:
 - General:** Calculation method (ISO 281, ISO 281:2008), tolerance field, axial clearance, and reference service life.
 - Operating Conditions:** Lubricant, lubricant temperature, and contamination level.
 - Shaft and Housing:** Shaft diameter, shaft tolerance, housing bore diameter, and housing tolerance.
 - Calculation Method:** SKF rating method, SKF modified rating method, and SKF reference rating method.
- Wahlgrößen (Middle):** A bar chart showing the bearing life rating (L10h, L50h, L90h) for different bearing types (Roller bearing 1, 2, 3, 4, 5, 6). The x-axis represents the bearing type, and the y-axis represents the life rating in hours. A value of $N_1 = 5000$ h is indicated.
- Hertzische Pressung (Middle):** A 3D visualization of the contact stresses between the bearing rollers and the raceway. The color scale ranges from 0.000 to 1769.000 N/mm^2 .
- Stresses beneath the contact area (Bottom):** A graph showing the horizontal stress distribution (in N/mm^2) versus the depth (in mm) for different stress components: σ_x , σ_y , σ_z , and τ_{max} . The x-axis ranges from 0 to 0.75 mm, and the y-axis ranges from -2000 to 400 N/mm^2 .
- Force (Bottom):** A 3D visualization of the force distribution on the bearing rollers. The color scale ranges from 0.000 to 2859.356 N .

Bearing designer

- Sizing function for bearing inner geometry
- Define ranges e.g., for rolling element diameter, pitch diameter, no. of rolling elements and others
- Software calculates possible bearing designs
- For each design, load capacity and properties of inner geometry are calculated
- Allows for specific, optimized design of bearings, in particular slewing bearings

Load distribution with elastic rings

- Elastic or stiff rings
- Ring deformation influencing load distribution

Calculation by SKF® and TIMKEN®

- Cloud based calculation
- Bearing forces are transmitted from KISSsoft to SKF cloud-based tool
- Bearings are rated by SKF, and results are sent back to KISSsoft

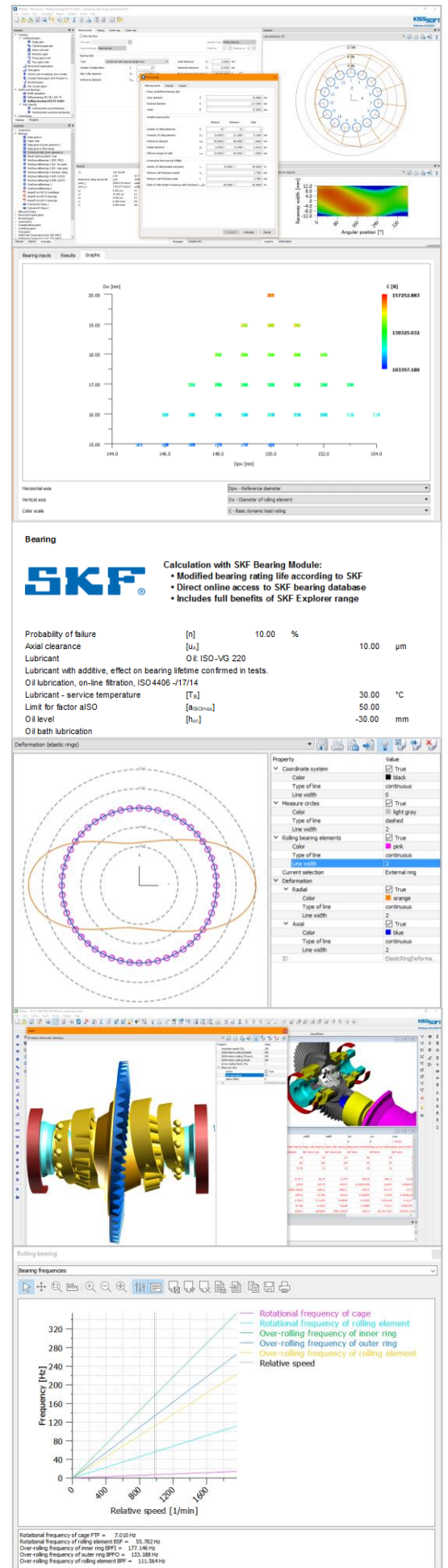

Shaft-hub connections

Cylindrical interference fit

- Strength rating along DIN 7190
- Sizing function for tolerances
- Stress calculation for stepped hub and hollow shaft
- Considers torsional, radial, and bending load, including centrifugal loads
- Calculation of mounting temperatures

Conical interference fit

- For different mounting procedures
- Calculation along Kollmann
- Considers cone angle and cone angle tolerances

Key

- Geometry along DIN 6885, ANSIB17.1
- Strength rating along DIN 6892
- Woodruff key

Involute spline

- Geometry along DIN 5480, ISO 4156, ANSIB92, own definition
- Tolerances along DIN 5480, ISO 4156, ANSIB92, own definition
- Reference profiles along DIN 5480, ISO 4156, ANSIB92, own definition
- Strength rating along Niemann or DIN 5466
- Crowned spline

Straight sided spline

- Geometry along DIN 5464, DIN 5471, DIN 5472, ISO 14, own definition
- Strength rating along Niemann
- Graphical output

Serrated spline, polygons

- Geometry along DIN 5481
- Strength rating along Niemann
- 3-sided and 4-sided polygon along DIN 32711, DIN 32711

Hirth coupling

- Includes Voith ® profiles
- Strength and geometry calculation

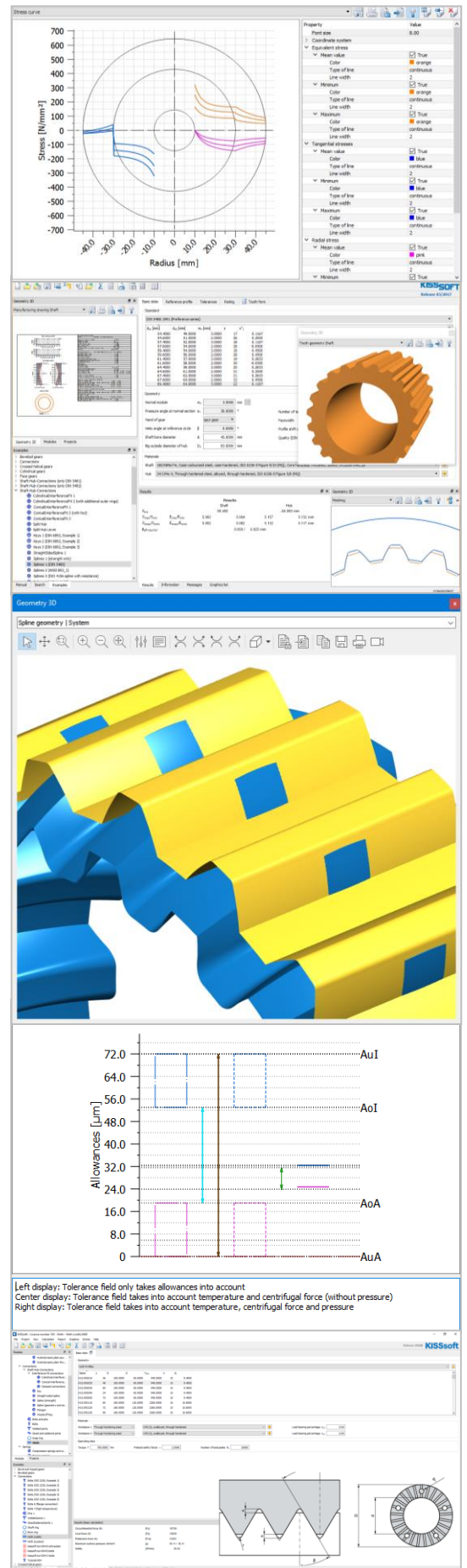

High strength bolting modules

Bolt rating along VDI2230, configurations

- Connection under axial load only
- Connection under axial and shear load
- Flange type bolted connection
- Arbitrary bolting pattern
- Import of FEM results for loading condition
- Sizing function for bolt length and bolt diameter

Bolt, nut and washer types

- Own bolt geometry definitions
- Own nut and washer definition
- Washers: ISO 7089, ISO 7090, ISO 7093-1, ISO 7093-2, ANSI / ASME 18.22.1, own definition
- Nut: ISO 274, DIN EN 2432, DIN EN 24035, DIN EN 28673, DIN EN 28675, ANSI / ASME B.18.2.2, own definition
- Bolt: ISO 4762, ISO 4014, ISO 4017, ISO 1207, ISO 8765, ISO 8676 and others
- Strength classes, 8.8, 10.9, 12.9, A1...A5, SAE J492, own definition
- Extension sleeves under bolt and nut

Tightening

- Considers different tightening procedures
- Considers pre-tension loss
- Considers friction in thread and under head / nut

Temperatures

- For low and high temperatures
- Considers assembly temperature, temperature of bolt and temperature of clamped parts

ANSYS Integration

- KISSsoft integrated in ANSYS by CADFEM
- Calculate bolt loads in ANSYS and perform strength rating along VDI 2230 based on KISSsoft
- For arbitrary bolting patterns, considering clamped parts elasticity

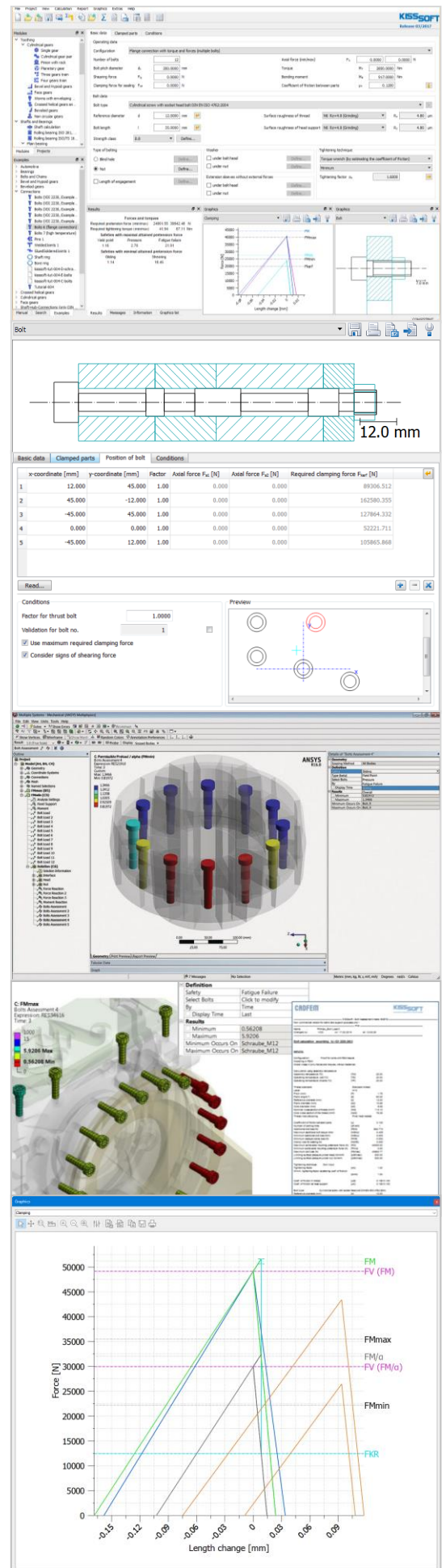

Spindle drives

Calculations

- Safety factor against buckling, contact pressure and torsion
- Geometry along DIN 103 and own definition
- For static, alternating and pulsating loads

Shear pins, circlips

Calculation along Niemann / Seeger

- Bolt under shearing
- Cross pin under torque
- Longitudinal pin under torque
- Pin under bending
- Shear pin system
- Hub and shaft circlip

Calculations

- Static or fatigue loads
- For full or notched type pins
- Material database
- Sizing function for pin diameter

General purpose modules

Hertzian contact

- Contact between balls, cylinders, ellipsoid and plane, arbitrary body
- Calculation of contact ellipse dimension
- Calculation of contact and sub-surface stress

Local stress analysis

- Strength verification along FKM guideline
- For steel and aluminum
- For 1, 2 and 3-dimensional stress state

Tolerance analysis

- Min / Max values, statistical calculation
- Standardized or user defined tolerances

Belt drives, chain drives, clutches

- Chain sprocket geometry
- Belt and chain length
- Belt and chain strength
- Wet clutches along VDI 2241-1

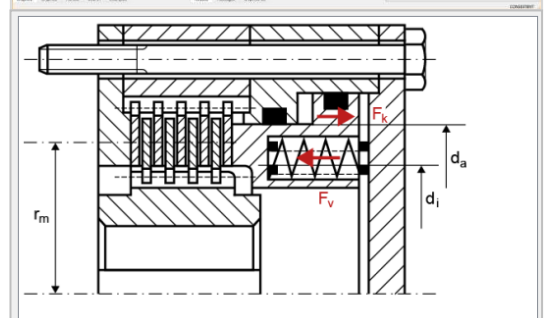
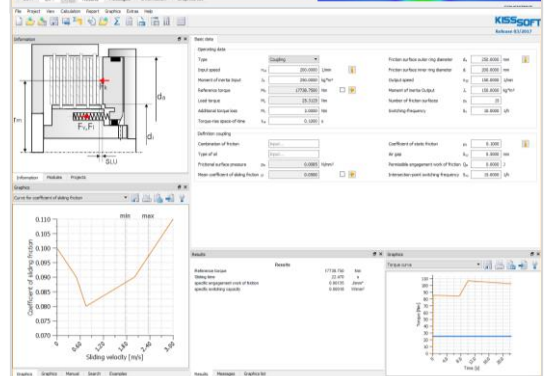
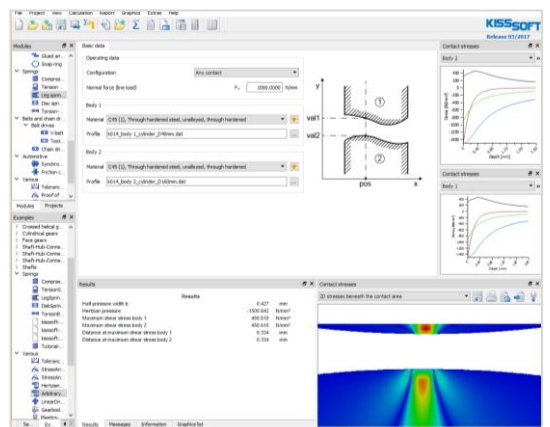
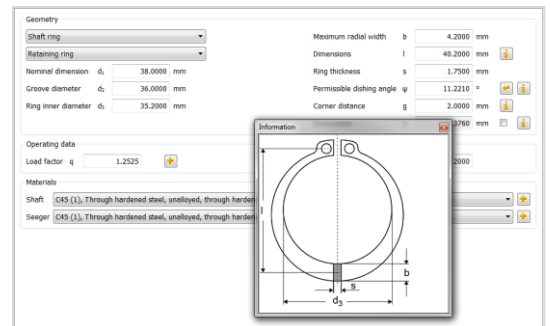
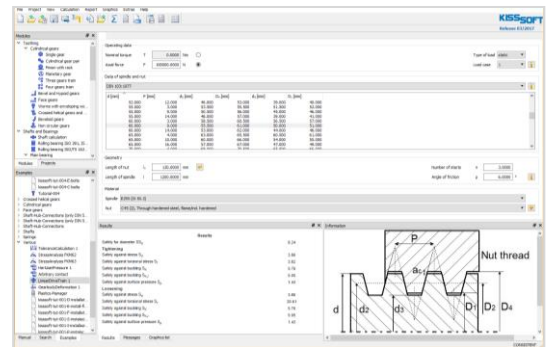

Springs modules

Compression springs

- Geometry along DIN 2098 or own definition
- Tolerances along DIN 2095 or DIN 2096
- Calculation along EN 13906-1
- Goodman diagram for spring / wire strength
- Spring relaxation
- Sizing for wire diameter and active coils / windings

Tensile springs

- Different end geometries
- Tolerances along DIN 2097 or DIN 2096
- Calculation along EN 13906-2
- Goodman diagram for spring / wire strength
- Spring relaxation
- Sizing for wire diameter and active coils / windings

Garter springs

- Tolerances along DIN 2194
- Calculation along EN 13906-3
- Sizing function for wire diameter and active coils / windings
- For static or dynamic stress loading

Spring disks

- Geometry along DIN 2093, Series A / B / C or own definition
- Calculation along DIN 2092
- Sizing function for number of disks in stack
- For static or dynamic stress loading
- Non-linear spring stack stiffness

Torsional spring

- Different head forms
- Single or multiple springs
- Calculation along DIN 2091
- Sizing function for selection of torsion bar diameter and shank length

Conical spring

- Tolerances along DIN EN 15800
- Spring standard DIN 2076, DIN EN 10270, DIN EN 10218

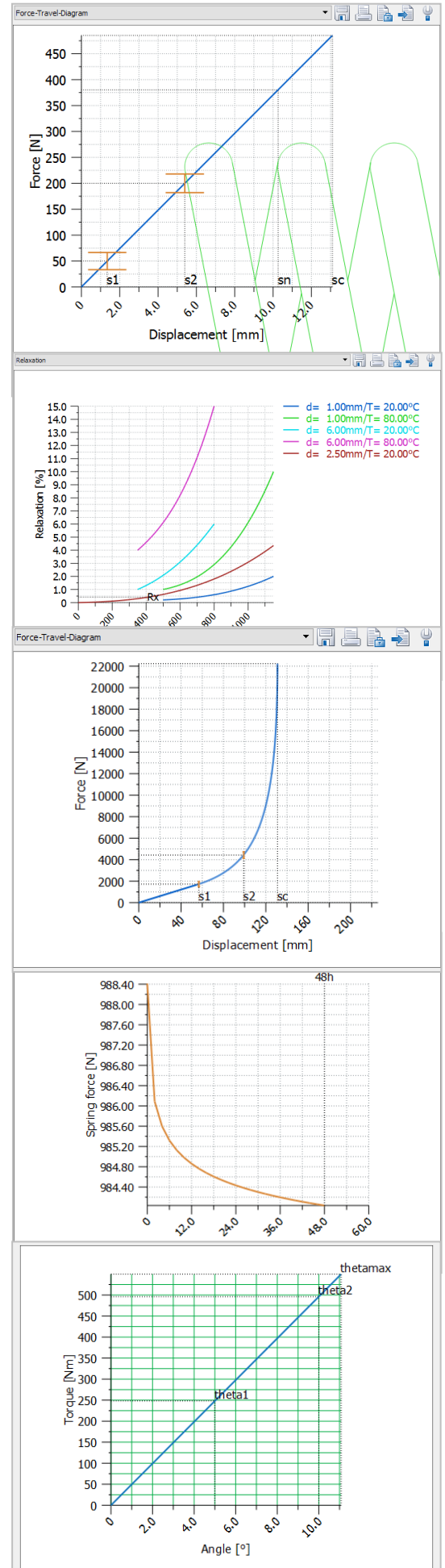





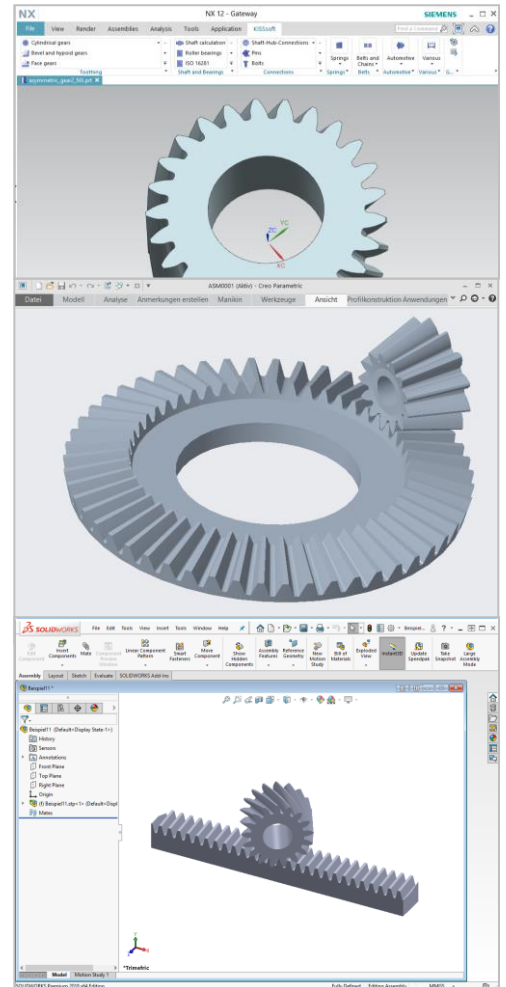

CAD interfaces

KISSsoft may include the below CAD interfaces to various systems. Thus, at the pressing of a button, the gears defined in KISSsoft can be exported to any of the below-mentioned CAD platforms. Gear Geometries supported are indicated above.

A gear can be generated for an existing construction or, simply, as a new part. Gears are generated by polylines, circular arc approximation or splines. The exact tooth profile is generated by manufacturing simulation considering tools like shaping cutter or protuberance hob. In addition, it is possible to place several gears on shafts already modelled in the CAD environment.

Neutral interfaces in 2D and 3D formats complete the CAD-specific export functions.



Feature/CAD	 SolidWorks Autodesk Authorized Developer Autodesk Inventor	 Solution Partner SolidEdge: Solution Partner	 Solution Partner UGS NX: Level-Gold	 PTC Partner Advantage Creo Parametric	 CATIA	HiCAD	Parasolid / Neutral Format interface (step)	
Version	2020 - 2023	2021-2024	2021-2024	NX 2007- NX 2312	Creo 5-8	V5 R20-32), V5-V6 R2013-2022)	2018 - 2023	
Cylindrical gears, spur/ helical gears	✓	✓	✓	✓	✓	✓	✓	✓
Cylindrical gears, internal/ external teeth	✓	✓	✓	✓	✓	✓	✓	✓
Worm/ cylindrical worm wheel	✓	✓	✓	✓	✓	✓	✓	✓
Worm/ enveloping worm wheel	✗	✗	✗	✗	✗	✗	✗	✓
Rack	✓	✓	✓	✓	✗	✗	✓	✓
Bevel gears, straight	✓	✓	✓	✓	✓	✓	✓	✓
Bevel gears, helical	✗	✗	✗	✗	✗	✗	✗	✓
Bevel gears, spiral	✗	✗	✗	✗	✗	✗	✗	✓
Face gears	✗	✗	✗	✗	✗	✗	✗	✓
Beveloid gears	✗	✗	✗	✗	✗	✗	✗	✓
Splines (Shaft-hub)	✓	✓	✓	✓	✓	✓	✓	✓
Toothing on existing shaft	✓	✓	✓	✓	✓	✓	✗	✗
Shafts	✓	✓	✓	✓	✗	✗	✗	✓
CAD add-in menu	✓	✓	✓	menu-driven only	✗	Selection menu	✗	✗
Manufacturing data	✓	✓	✓	✓	✓	✓	✗	✗

Export to CAM

KISSsoft includes a highly accurate detailed modeler for 3D gear geometries. Based on the geometry generated in KISSsoft, mold cavities, electrodes or final parts may be machined using 5-axis CNC machines.

For most gears, the 3D models can be generated including a protuberance to facilitate a roughing and a final machining operating. 3D models include gear modifications like lead, profile or topological modifications including chamfers or tip rounding.

Applications

Gears or cavities successfully machined by our customers include:

- Spur, helical and herringbone gears
- Spur, helical and spiral bevel gears
- Bevel gears with constant or varying tooth height
- Spur and helical face gears
- Worm gears (different shapes)

Geometries may be imported into any CAM software. Imported geometry includes profile and lead modifications, root geometry simulated from manufacturing, inner diameter, tip chamfer or rounding. Geometry resolution is finer than 0.1µm.

Verification

Tests have confirmed that contact patterns of e.g., spiral bevel gears are matching with predictions calculated in KISSsoft.

Request specific information and technical papers on the subject from your local authorized reseller.

Gear geometry measurement may be controlled using KISSsoft measuring data (flank and root coordinates on measurement grid) and point normal vectors exported in different formats (e.g., to suit Gleason, Klingelnberg or Wenzel gear testers).

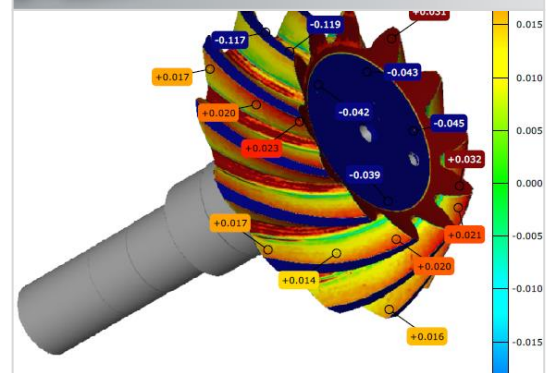
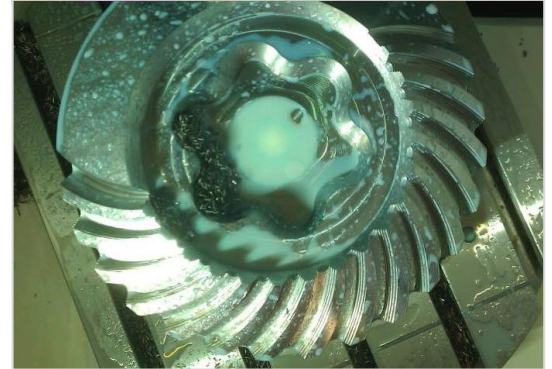
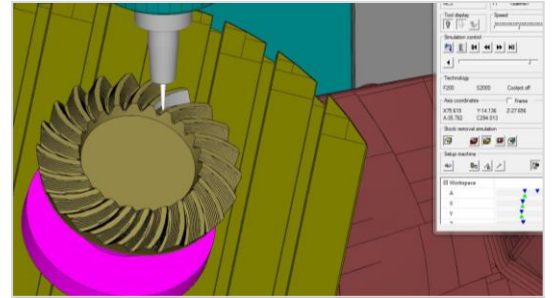

KISSsoft AG
A Gleason Company
Rosengartenstrasse 4
8608 Bubikon
Switzerland

+41 55 254 20 50
info@kisssoft.com
www.kisssoft.com